

## A brief review on industrial remanufacturing of structural and functional components: Wire-Arc Additive Manufacturing Technique

Japheth Obiko<sup>a\*</sup>, Talent Kachomba<sup>b</sup>, James Mutua<sup>c</sup>, Joshua Ngoret<sup>c</sup>, Samson Jeje<sup>a</sup>, Mxolisi Brendon Shongwe<sup>a</sup> and Nicholus Malatji<sup>a</sup>

<sup>a</sup>Department of Chemical, Metallurgical and Materials Engineering, Tshwane University of Technology-Pretoria, South Africa

<sup>b</sup>Department of Mechanical and Mechatronic Engineering, Pan African University Institute for Basic Sciences, Technology and Innovation (PAUISTI), Nairobi, Kenya

<sup>c</sup>Department of Mechanical Engineering, Jomo Kenyatta University of Agriculture and Technology Nairobi, Kenya

### ARTICLE INFO

#### Article history:

Received 12 January 2023

Accepted 15 May 2024

Available online

15 May 2024

#### Keywords:

Wire-arc additive

manufacturing

Failure

Remanufacturing

Repair

Downtime

Components

### ABSTRACT

Many industries rely heavily on the availability and reliability of complex structural and functional components to execute operations efficiently. However, failure of components during service occurs due to exposure to unfavourable operating conditions, causing wear and tear of these components. The damage will result in costly downtime and potential safety hazards. Repairing, remanufacturing and refurbishing these complex parts is critical. Restoring broken structures into operation ensures the smooth operation of the industry, thus preventing losses. Conventionally, repairing parts poses a challenge. However, Wire-arc additive manufacturing (WAAM), which employs the welding principle, has revolutionised component repairing or remanufacturing. This paper reviews the literature on manufacturing complex parts, repair, remanufacture and refurbishment of broken structural and functional parts using WAAM technology. This paper also highlights the various strategies and techniques currently used to improve the quality of WAAM 3D printed parts. The study further covers the immense potential of WAAM in revolutionising the remanufacturing and repair of components. The review study has provided a roadmap for future research and development to take full advantage of this new cutting-edge manufacturing technology.

© 2024 Growing Science Ltd. All rights reserved.

## 1. Introduction

Additive Manufacturing (AM) has become popular as a future manufacturing tool. This method allows the manufacture or repair of components through layer-by-layer deposition (Onuiké & Bandyopadhyay, 2019; Wilson et al., 2014; Yusuf et al., 2019). The technique poses numerous advantages compared to conventional manufacturing techniques (Lee et al., 2022; A. Singh et al., 2020). AM provides great potential in reducing production time, cost and material wastage (Balashanmugam, 2021; Krishna et al., 2021; M. Srivastava & Rathee, 2022). Conventional manufacturing techniques are often subtractive, thus resulting in high production costs and material waste (Gibson et al., 2015a; Ivanova et al., 2013). AM potentially reduces carbon footprint by optimising design and reducing cost and material waste (Elgazzar & Abdelghany, 2022; S. R. Singh & Khanna, 2021; Wandtke et al., 2023; Wilson et al., 2014). The potential of AM is growing steadily and is accepted to take centre stage in the industry for different applications, hence shaping the future of the manufacturing industry (Gornet, 2017; Mhapsekar et al., 2018). AM has a wide application in aerospace, construction, manufacturing, automotive, biomedical, oil and gas industries due to its versatility, efficiency, and ability to create complex geometries that traditional manufacturing processes cannot achieve (Behera, 2020; Ford, 2016; Najmon et al., 2019; Yusuf et al., 2019). This technique started over the last 30 years (Bourell, 2016; Yang & Luo, 2019). Studies show that AM improves sustainable manufacturing through efficient resource utilisation and closed-loop material flows (Rodriguez et al., 2018), thus enhancing production through product and process redesign (Ford, 2016). Redesigning and reducing material waste reduces lead time and production costs during AM (Frazier, 2014; Wandtke et al., 2023).

\* Corresponding author.

E-mail addresses: [japheth.obiko97@gmail.com](mailto:japheth.obiko97@gmail.com) (J. Obiko)

ISSN 2291-8752 (Online) - ISSN 2291-8744 (Print)

© 2024 Growing Science Ltd. All rights reserved.

doi: 10.5267/j.esm.2024.5.004

The four basic categories of metallic AM processes are powder bed fusion (PBF), sheet lamination, binder jetting, and directed energy deposition (DED) (Dinovitzer et al., 2019; Friel, 2015). The basis of classifications is through factors such as application, material type, and intended output (Dass & Moridi, 2019). The brief discussion of these processes is as follows:

- PBF uses a bed of fine metallic powders to create 3D objects. The process involves selectively melting or sintering the powder particles together, layer by layer, based on a digital model. A laser or electron beam typically fuses the powder particles, solidifying each cross-section until the entire object formation occurs (Zhang & Liou, 2021).
- PBF, sheet lamination method uses thin sheets or layers of material such as paper, plastic, metal foils, or wood. Each layer is cut or moulded according to the pattern before being piled on top of one another and bonded under heat, pressure, or adhesives (Friel, 2015).
- Binder jetting involves carefully injecting a liquid binder over a bed of powdered material, often metal or sand. Layer by layer, the binder bonds the powder particles by fusing at high temperatures to obtain its final solid shape. Binder jetting is a prototyping technique that produces metal components. This production process is popular in the industry due to its speed, cost-effectiveness, and ability to generate complicated shapes (Salmi, 2021).
- DED offers a greater production efficiency than the previously described AM technologies. DED can produce components faster and is well-suited for repairing existing parts by adding a material to specified regions, ultimately reducing downtime during maintenance. This process has received attention for various applications (Ahn, 2021; Babu et al., 2015; Najmon et al., 2019). DED uses a concentrated heat energy source such as an electron beam (Negi, Nambolan, et al., 2020; Sames et al., 2016; A. Singh et al., 2020; Svetlizky et al., 2021), plasma arc (Alberti et al., 2016; Artaza et al., 2020; Dass & Moridi, 2019; Ivántabernero et al., 2018), laser (Ding et al., 2015; Lorenz et al., 2020; Rumman et al., 2019; Yoo et al., 2023), and electric arc (F. Li et al., 2017; Rosli et al., 2021; Sames et al., 2016; A. Singh et al., 2020; Svetlizky et al., 2021) to melt metallic feedstock and deposit it onto a substrate to build a component (Ahn, 2021). **Fig. 1** summarises the DED processes.

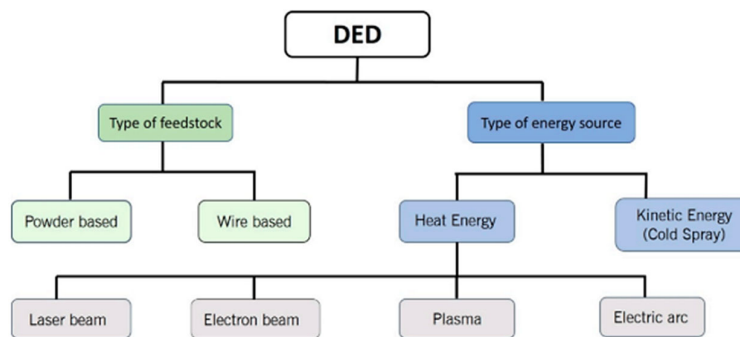
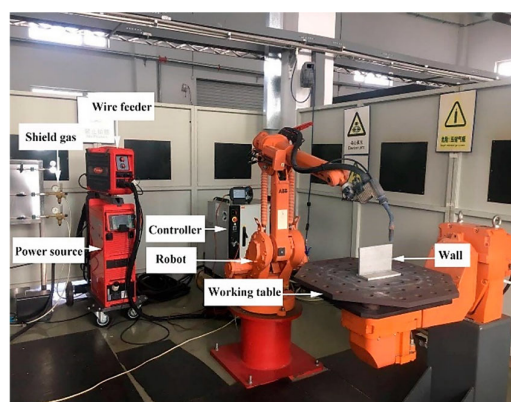

**Fig. 1.** DED, AM processes (Dass & Moridi, 2019).

## 2. WAAM Deposition process

### 2.1. Introduction to WAAM

Wire-Arc additive Manufacturing (WAAM), also called 3D printing, is a modern manufacturing method. This method builds parts layer-by-layer using the 3D model designed using computer-aided controller software (Tanvir et al., 2020; Yuan, Ding et al., 2020). WAAM development through standard, off-the-shelf welding equipment such as welding power source, torch and wire feeding systems, as shown in **Fig. 6**.



**Fig. 2.** WAAM parts and operation (Ren et al., 2020).

Motion is aided either by robotic systems or computer numerically controlled gantries, as in **Fig. 3** (J. Ding et al., 2015; Ren et al., 2020). The Physical object is produced directly from the CAD model (Williams et al., 2015). WAAM has gained attention recently due to its ability to reduce lead time and production costs compared to conventional methods, such as casting (Ren et al., 2020; Taşdemir & Nohut, 2020), welding (Gary S. Schajer, 2013; Veiga et al., 2023) and machining (Veiga et al., 2023). This technique has higher deposition rate (3-8 kg/h), cheap material utilization, and structural quality compared to PBF systems (Le et al., 2021). Thus, this method finds a wide application and is recommended for industrial manufacturing and component repair (Li et al., 2017). WAAM can remanufacture end-use parts in aerospace, automotive, petrochemical, power plants, defence, and construction industries (Singh & Khanna, 2021; Wu et al., 2018). These wide applications are due to the capability of this technique to repair components using a range of materials such as titanium alloys, nickel alloys, steel, aluminium alloys, shape memory alloys, and refractory metals (Raut & Taiwade, 2021). WAAM capability reduces production cycle time, mean time to repair and downtime (Dias et al., 2022). This process has a low capital cost, thus providing a solution for industrial production and small shops for manufacturing and repair (Attaran, 2017; Reisgen et al., 2020). Moreover, metal wires are cheaper, readily available, and safer to handle, keeping the capital and operational costs low (Cunningham et al., 2017; Yehorov et al., 2019).

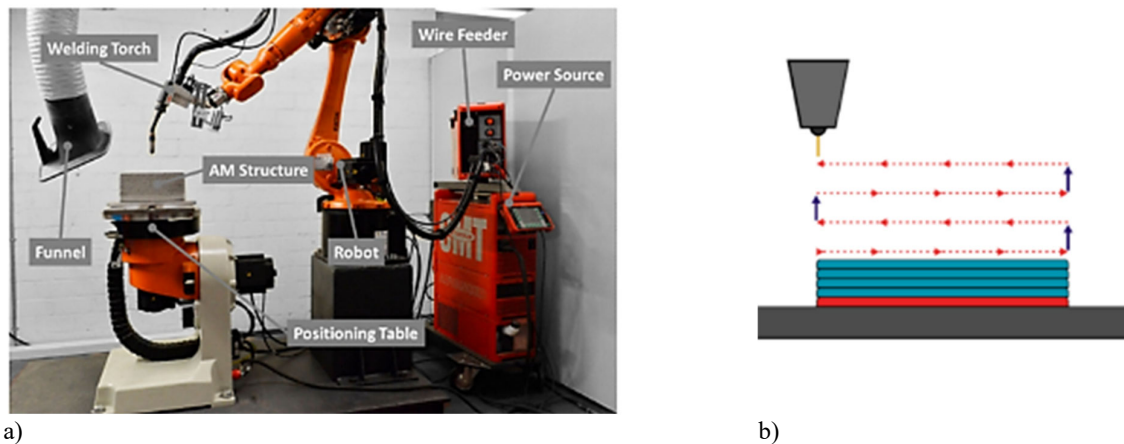
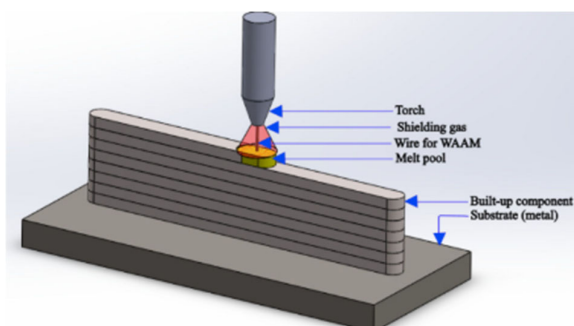

**Fig. 3.** a) Robot-controlled WAAM systems b) torch path illustration during manufacturing (Köhler et al., 2019).

Compared to conventional methods such as casting and machining play a role in manufacturing structural and functional components with complex geometry (Hawalдар & Zhang, 2018; Karpagaraj et al., 2020; Mhapsekar et al., 2018). These production techniques are time-consuming and costly (Cunningham et al., 2017). The product quality depends on the experience of the engineers and designers (Attaran, 2017; Cagan & Buldum, 2021; Hawalдар & Zhang, 2018; Meiners et al., 2020). Production time and costs negatively affect the effectiveness of repairing broken parts. These factors cause heavy losses due to downtime of machine parts failure (Attaran, 2017). Therefore, WAAM has become a superior production process for large-scale industrial production (Li et al., 2022). Williams *et al.* (2015) reported that cost savings for WAAM-produced parts range from 7% to 69%. However, the reliability of this method for component manufacture requires an understanding of the deposition effects and resulting properties of the printed parts (DebRoy et al., 2018; Gorsse et al., 2017; Motallebi et al., 2022; Peng et al., 2021).

## 2.2. WAAM Process

WAAM technique is used as a manufacture and repair technique for most industrial components (Lee et al., 2022). This technique employs a traditional welding technology (Shah et al., 2023). WAAM process uses an electric arc to melt the wire (feedstock) that is deposited onto a substrate (Ryan, 2018; Xin et al., 2021). A typical WAAM process is shown in **Fig. 5**.



**Fig. 4.** WAAM Basic Principle (Shah et al., 2023).

As mentioned, WAAM process utilises an electric arc as heat source (**Fig. 1**), which melts wire feedstock and deposits it one layer at a time to produce three-dimensional objects. Different heat sources for WAAM are readily available for application. The heat source includes: gas metal arc welding (GMAW) (Artaza et al., 2019, 2020; Ding et al., 2014; Ivántabernero et al., 2018; Kapil et al., 2019; Karunakaran et al., 2009; Kozamernik & Bra, 2020; Michel et al., 2019; Prado-Cerqueira et al., 2017; Rodrigues et al., 2021; Rosli et al., 2021; Warsi et al., 2022; Xiong et al., 2019; Yuan, Ding, et al., 2020), tungsten arc welding (GTAW) (Artaza et al., 2020; Negi, Kapil, et al., 2020; Rodrigues et al., 2022; Rodriguez et al., 2018; Somlo & Sziebig, 2019; X. Wang et al., 2020; Yuan, Pan, et al., 2020; W. Zhang et al., 2021; X. Zhang, Wang, et al., 2019; Zhou et al., 2021), plasma arc welding (PAW) (Aldalur et al., 2020; Bai et al., 2018; Diourté et al., 2021; Geng et al., 2017; Hassel & Carstensen, 2020; Kapil et al., 2018; Reisch et al., 2020; Ünsal et al., 2020; Veiga et al., 2020; J. Wang et al., 2020) and Cold Metal Transfer (CMT) (Ge et al., 2018; W. Zhang et al., 2021) (Marinelli et al., 2019; Ríos et al., 2019) as shown in Fig. 5. Williams et al. (2015) and Y. Liu et al. (2012) found that GTAW techniques produce high-quality welds with enhanced precipitation strengthening and reduced porosity than GMAW for Al5083 welds (Thapliyal, 2019). The close control of the material and heat input offered by GTAW for aluminium alloy deposition makes it a better technique than GMAW. Process control of GMAW can improve deposition rate (Geng et al., 2017). The typical deposition rates for direct energy deposition techniques are 2-4 kg/h (PAW), 1-2 kg/h (GTAW) and 3-4 kg/h (GMAW) according to Ahn (2021). Although GMAW is used widely in WAAM, this technique falls short because of poor arc stability (Li et al., 2022).

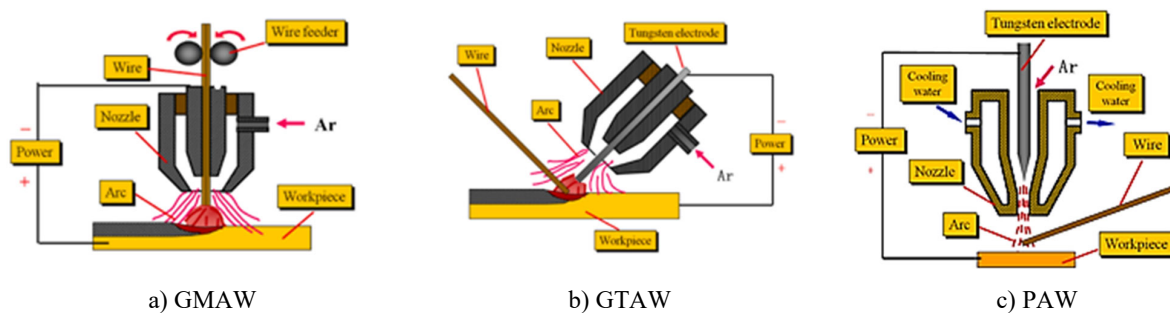

**Fig. 5.** WAAM welding deposition techniques (Y. Li et al., 2022; Shah et al., 2023).

These shortcomings resulted in the application of Cold Metal Transfer (CMT) WAAM techniques. The CMT method has low heat input, good arc stability, low spatter and the typical deposition rate ranges in 2-3 kg/h (Y. Li et al., 2022). This method is highly recommended as the main candidate in realising the WAAM deposition and repair. The low heat input causes stable residual stress compared to the other mentioned methods having high heat input (Koli et al., 2023; Raut & Taiwade, 2021). The CMT technique offers a precise control over the creation of porosity, controlled metal deposition, and minimal thermal heat input for WAAM. Hence, high product quality with improved mechanical properties (Selvi et al., 2017). Low heat input during welding causes a lower weld pool temperature and fine grain structure, thus preventing hydrogen from being trapped causing porosity (Thapliyal, 2019).

## 2.2. Adoption of AM techniques in repair

The adoption of AM techniques is mainly due to capital cost, part size, deposition rate, post-processing requirements, freedom of design, ease to customise and delivery times (Chaturvedi et al., 2021; Saboori et al., 2019; Wu et al., 2018). Leino et al. (2016) pointed out that AM drives the circular economy. This model ensures components maintain their best working condition. For example, parts repair, refurbishment and remanufacturing using DED aims to restore product value during its life cycle (Kanishka & Acherjee, 2023; Leino et al., 2016). This design process requires optimization of process parameters: feed rate, voltage, current, travel speed and inter-pass idle time. Research on material waste minimisation, repair and remanufacturing of functional components has attracted attention (Babu et al., 2015; Najmon et al., 2019; Thapliyal, 2019). DED additive manufacturing can carry out site-specific deposition and repair, according to Svetlizky *et al.* (2021). This approach implies that instead of replacing the entire component, DED may be used to repair the component by depositing material only where needed (Svetlizky et al., 2021). Corrosion, thermal stress, changing temperature cycles, and collision can all cause component damage (Javaid & Haleem, 2019; Pinkerton, 2010; Piscopo & Iuliano, 2022). **Table 1** summarises the application of DED techniques in repairing structural defects.

The DED technique has become a leading technique in the repair and remanufacturing of various functional industrial components such as aerofoil leading edges (Piscopo & Iuliano, 2022), thin-curved compressor blades (Saboori et al., 2019; Yilmaz et al., 2010), tools and moulds (Piscopo & Iuliano, 2022; Ren et al., 2006), turbine blades, as in **Fig. 6a** (Piscopo & Iuliano, 2022; Saboori et al., 2019; Wilson et al., 2014), Grey cast iron diesel engine, **Fig. 3b** (Bennett et al., 2016; Piscopo & Iuliano, 2022), BR715 HPT case flange, **Fig. 6c** (Gasser et al., 2010; Piscopo & Iuliano, 2022), Titanium alloy groove wall (**Fig. 6d**) (Gasser et al., 2010; Piscopo & Iuliano, 2022), AM355 steel T700 blisk, Figure 6e (Piscopo & Iuliano, 2022), titanium blisk, **Fig. 6f** (Nowotny et al., 2007; Saboori et al., 2019), crankshaft, **Fig. 6g** (Koehler et al., 2010; Piscopo & Iuliano,



2022; Saboori et al., 2019), Gas turbine Inconel 718 compressor seal, Figure 6h (Mudge & Wald, 2007; Saboori et al., 2019). The remanufacturing has addressed the restriction imposed by strict environmental laws. Disposal of industrial component has greatly increased causing environmental pollution. Lee *et al.* (2022) has simplified the product life cycle as shown in Fig. 7. Laser-based DED-AM has been employed quite often in repairing industrial components (Piscopo & Iuliano, 2022; Saboori et al., 2019). This technique has the ability to produce tiny, precise layers with great accuracy (even up to less than one millimetre) but faces great challenge because of its high equipment costs (Gibson et al., 2015b; Saboori et al., 2019). Table 2 shows the application of Laser AM for repair of structural and functional industrial parts. PBF can create complex geometries with high precision and material compatibility. However, the process requires significant pre-processing and post-processing (Rahito et al., 2019). Therefore, other DED processes have emerged for this application. For example, Cold Spray Technology involves spraying metal powder at high velocity onto a substrate. The kinetic energy of the particles causes plastic deformation upon impact. Hence, causing bonding of powder and the substrate. This process is beneficial in repairing components without thermal degradation. However, this process faces challenges in material compatibility and geometrical complexity, therefore limited in some applications (Rahito et al., 2019).

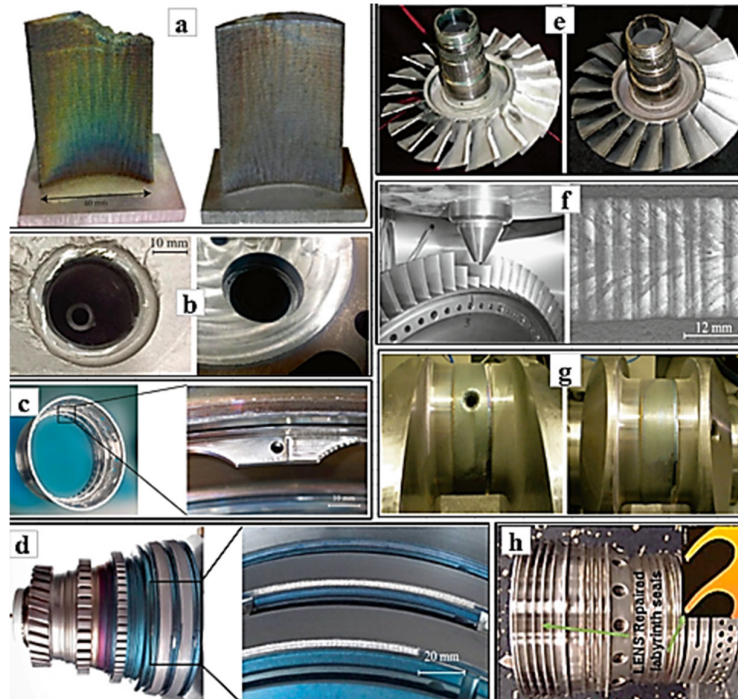

**Fig. 6.** DED Repaired components: (a) turbine blades (Saboori et al., 2019), (b) Diesel engine (Piscopo & Iuliano, 2022), (c). BR715 HPT case flange (Piscopo & Iuliano, 2022), (d) Titanium alloy groove wall (Piscopo & Iuliano, 2022), (e). AM355 steel T700 blisk (Piscopo & Iuliano, 2022), (f) Titanium blisk (Saboori et al., 2019), (g) Crankshaft (Saboori et al., 2019), (h) Gas turbine Inconel 718 compressor seal (Saboori et al., 2019).

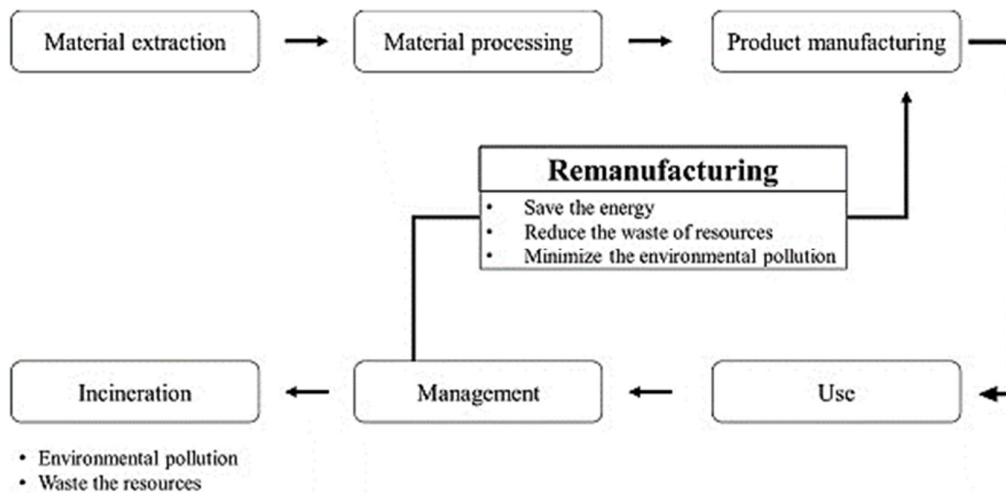

**Fig. 7.** Product remanufacturing life-cycle (Lee et al., 2022).

**Table 1**

Repair work using DED-AM (Lee et al., 2022)

No.	Application	Ref
1	DED's suitability for restoring damaged PBF parts	(Oh et al., 2019)
2	The effectiveness of two slots with different geometric forms (rectangular and trapezoidal) in healing interior fractures influences the mechanical qualities of the restored components.	(Onuiké & Bandyopadhyay, 2019)
3	Fatigue behaviour following deposition of materials other than those in the substrate	(Sun et al., 2014)
4	Proposed a concave groove geometry for deposition of bead during repair using WAAM.	(Y. Li et al., 2019a)
5	A shield metal arc welding procedure for generating a hard face was investigated.	(Poonayom & Kimapong, 2018)
6	Metal powder surface remanufacturing of materials. The residual stress, cracking sensitivity, and mechanical characteristics of ductile iron were determined during a laser remanufacturing process.	(Y. Li et al., 2018)
7	Determination of self-heating characteristics of stainless-steel specimens repaired by DED during cyclic loading	(Balit et al., 2020)
8	Repair technique for damaged SUS 630 components using directed energy deposition	(Shim et al., 2021)
9	Hot forging die remanufacturing with the goal of improving performance	(Foster et al., 2019)
10	Environmental advantages of utilizing AM to remanufacture and repair high-value engineering components	(Wilson et al., 2014)
11	Microstructure, chemical composition, and mechanical properties of cross slide parts repaired using wire arc additive manufacturing (WAAM) with a different material from the substrate in machine tool remanufacturing	(Lee et al., 2022)
12	Effect of step over and torch tilting angle on a repair process using WAAM	(Baffa et al., 2022)
13	Fatigue strengthening of damaged steel members using wire arc additive manufacturing	(Ghafoori et al., 2023)

WAAM provides a solution for part repair due to its low material usage, high deposition rate, good structural quality and manufacture of large parts (Cunningham et al., 2018; Dinovitzer et al., 2019; Rodrigues et al., 2019; Williams et al., 2016; Zeng et al., 2020). WAAM process is more desirable in product manufacture due to the low cost of metal wire compared to powders (Lee et al., 2022; Rosli et al., 2021). WAAM has been used to repair structural and morphological defects (Lee et al., 2022; Li et al., 2019b; Patel et al., 2021; Senthil et al., 2021). However, the practical application of WAAM parts experiences several limitations caused by distortion and residual stress due to thermal effects during production (Raut & Taiwade, 2021). These defects occur due to process parameters such as energy input, high deposition rate, and large temperature gradient during production (Barath Kumar & Manikandan, 2022; Schroepfer et al., 2017; Wandtke et al., 2023). The focus of recent studies is to redesign the process to mitigate the common defects. Process parameters such as travel speed, wire feed rate, working distance, arc voltage, and deposition strategy, directly affect product quality (Koli et al., 2023; Le et al., 2021). Therefore, to improve product quality, process optimisation is paramount for both the manufacturing and repair processes (Kapil et al., 2022). During repair work, the metallurgy between the substrate and the deposited material also determines final product quality (Dargusch, 2017; Kulkarni et al., 2020; Meiners et al., 2020). The interface between the substrate and deposited material during repair work is prone to defects, which causes failure during operation (Albannai, 2022; Dinovitzer et al., 2019). The interface (substrate/weld metal) suffers from a high thermal gradient, resulting in a heat-affected zone (HAZ) (Baffa et al., 2022; Deng et al., 2022; G.P. et al., 2017; Lipskas et al., 2019). Studies show that critical damage occurs at the HAZ, causing a catastrophic failure for most industrial components (Eimer et al., 2021; Shojaati et al., 2020). This failure mechanism is due to microstructure inhomogeneity causing inferior mechanical properties (Caballero et al., 2019). Fig. 8 shows the different microstructure regions of 3D printed components.

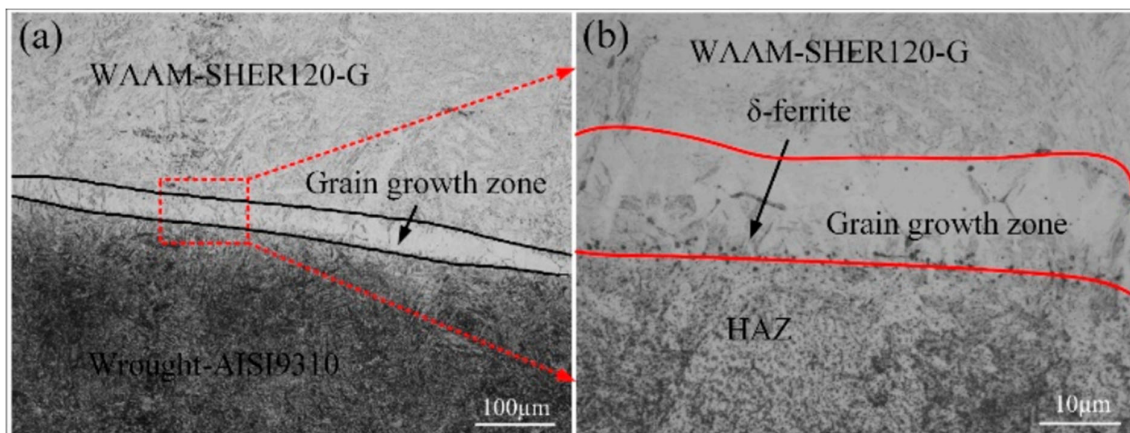

**Fig. 8.** Optical images of HAZ microstructure a) near the interface, and b) near the crack (Deng et al., 2022).

The feasibility and characterisation of repair, refurbishment and remanufacturing WAAM components has been reported in the literature (Campatelli et al., 2021; Vishnukumar et al., 2021). However, repair procedure using WAAM is conspicuously missing in the literature for most materials (Kanishka & Acherjee, 2023; Oh et al., 2019). The most commonly used repair technique is the application of groove defects. This defect is filled layer by layer using WAAM and other AM techniques (Branza et al., 2009). Other studies use different techniques to do repair such as circular truncated cone (Liu et al., 2014), V-shaped groove (Branza et al., 2009), U-shaped grooves (Graf et al., 2012) and concave groove (Li et al., 2019b). **Table 3**

summarises remanufacturing studies using WAAM. **Fig. 9** shows the procedure for carrying out repair, refurbishment and remanufacturing of components (Hu et al., 2017).

**Table 2.** Summary of Laser AM tests in repair, remanufacturing and refurbishment of components.

Property	Repair Method	Material	Application	Refs
Residual Stress	Laser AM	Steels Nickel alloys	Modern aircraft structures Gas turbine hot section, turbine blade knife edges, deteriorated steam circuit parts.	(Sun et al., 2014) (Acharya & Das, 2015; Bi & Gasser, 2011)
Hardness	Laser AM	Steels  Nickel alloys	Modern aircraft structures, chemical, maritime and aerospace industries, rail repair and enhancing, reconditioning of crankshafts  High strength, corrosion resistant at high temperatures, gas turbines, rocket engines, and nuclear reactors, machine parts in marine, chemical, and oil extraction industries	(Bi & Gasser, 2011; Clare et al., 2013; Koehler et al., 2010; Oh et al., 2019; Shim et al., 2021; Sun et al., 2014) (Marenych et al., 2021; Onuiké & Bandyopadhyay, 2019)
Tensile	Laser AM	Steels Nickel alloys	Modern aircraft structures, chemical, maritime and aerospace industries, tools turbine aerofoils	(Balit et al., 2020; Oh et al., 2019; Shim et al., 2021; Sun et al., 2014) (Wilson et al., 2014)
Microstructure	Laser AM	Steels  Nickel alloys	Modern aircraft structures, chemical, maritime and aerospace industries, buildings, bridges, rail repair and enhancing  gas turbines, rocket engines, and nuclear reactors, machine parts in marine, chemical, and oil extraction industries	(Balit et al., 2020; Clare et al., 2013; Oh et al., 2019; Shim et al., 2021; Sun et al., 2014) (Marenych et al., 2021; Onuiké & Bandyopadhyay, 2019)
Fatigue	Laser AM	Steels	Modern aircraft structures, buildings, bridges, rail repair and enhancing	(Ghafoori et al., 2023; Lewis et al., 2015; Sun et al., 2014)
Corrosion rate/ Wear	Laser AM	Steels	rail repair and enhancing	(Lewis et al., 2015)
Fractography	Laser AM	Steels	-	(Shim et al., 2021)

**Table 3.** Summary of remanufacturing of complex geometry using WAAM for different heat source.

Heat	Application	Description	Refs
GMAW	Repaired surface defects by combining groove milling, WAAM and finish machining	Fabrication error before machining <0.3mm. Buy to fly ratio of the deposited material - 92.1%. Adaptive control of deposition parameters to the shape of the grooves and the desired properties of the layers requires further research	(Y. Li et al., 2019a)
GMAW (CMT)	Hardfacing of AISI H13 with stellite 21 alloy using CMT	Studied cracking tendency using the microstructure and micro-hardness variation along the depth of HAZ. The dilution levels based on Fe content was lower compared to conventional arc welding deposits	(G.P. et al., 2017)
CMT	Proposed the repair corroded surfaces in AA5052 structures for marine industry using WAAM	WAAM repaired samples had corrosion rates equivalent to wrought parts.	(Vishnukumar et al., 2021)
GMAW, Simulation	Investigation on the performance of WAAM 5CrNiMo for hot forging die remanufacturing	The results showed that the grain size increased with the height of layers, while the microhardness decreased. No report on other mechanical property of the material.	(Hu et al., 2017)
GMAW	Application of wire arc additive manufacturing for repair of Monel (Ni-Cu based) alloy components.	Only studied the microhardness in as-welded and annealed + aged condition. As-welded samples had lower hardness values than the annealed +aged sample.	(Marenych et al., 2021)
CMT	WAAM for the fatigue strengthening of damaged steel members	WAAM process was found to introduce compressive residual stresses and can be mitigated by machining the WAAM to a pyramid-like shape. The study did not investigate the effect of different process parameters on the fatigue performance of the repaired specimens.	(Ghafoori et al., 2023)
GTAW	WAAM technology in repair of TC17 titanium alloy, and the microstructure evolution and mechanical properties of the repaired specimen	The results show that WAAM technology might be a potential and economical method to repair damaged blade. The research was limited to TC17 alloy and may not be applicable to other materials. Other factors such as corrosion resistance and fatigue properties were not considered as they are critical in the performance of aerospace blades.	(Zhuo et al., 2020)
GMAW, CMT	The development of a retrofit kit that provides additive capabilities to an existing milling machine, allowing automatic repairing of components	The study investigated the effect of repairing processes on dimensional accuracy, surface finish and mechanical properties such as fatigue strength, ductility, toughness of the repaired components	(Campatelli et al., 2021)

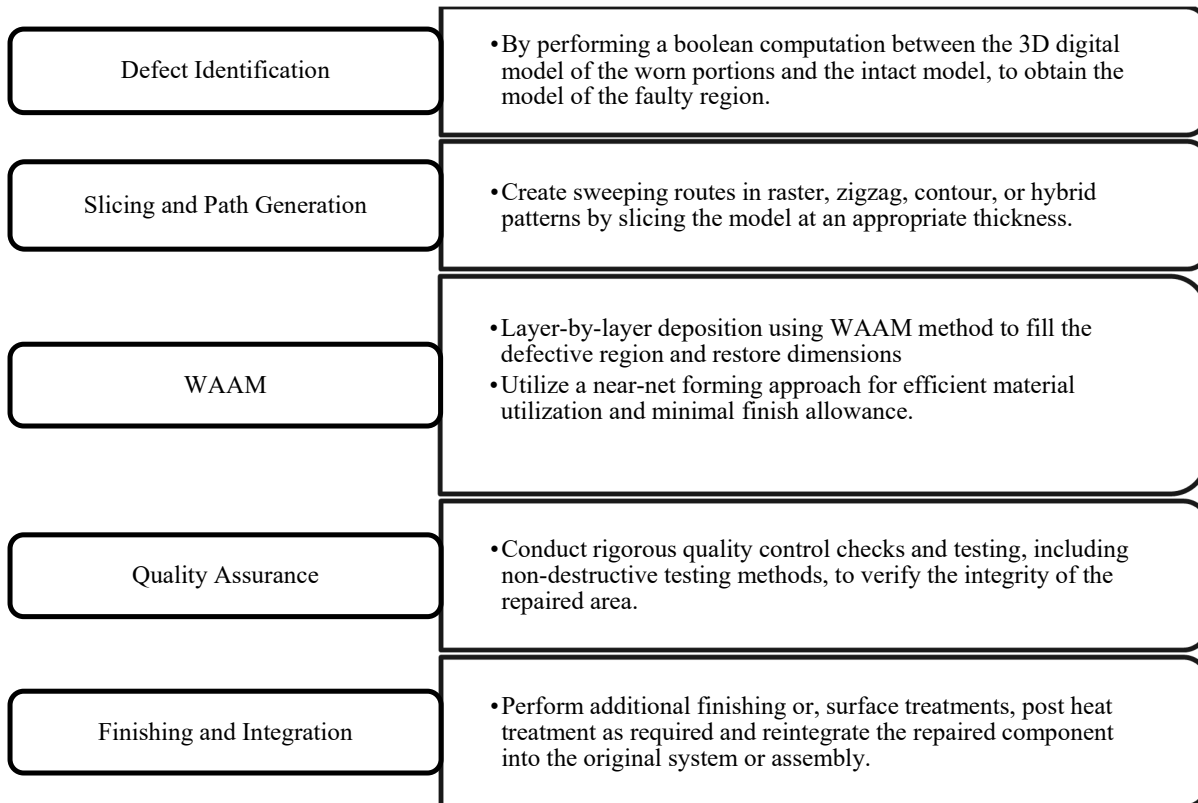

**Fig. 9.** Remanufacturing, repair and refurbishment of components using WAAM (Hu et al., 2017).

### 3. Materials and application

#### 3.1. Titanium alloys

Titanium alloy exhibits superior properties such as high strength-to-weight ratio, low density, and high corrosion resistance. Due to these properties, this alloy has found a wide application in the industry, especially aerospace (Williams et al., 2016; Zhuo et al., 2020), marine (Taek et al., 2014), biomedical applications (Varghese, 2003). WAAM technique has been widely used to repair broken armour vehicles (Lin et al., 2021). This technique has necessitated cost savings since the cost of carrying spare parts and docking for repairs has been too high and risky (Lin et al., 2021; Taşdemir & Nohut, 2020; Ziółkowski & Dyl, 2020). In combat operations, WAAM plays a role in repairing military ships. The technique allows component repair where a fault occurs, unlike carrying timely unnecessary spare parts. Zhuo *et al.* (2020) provided a potential and economical method for repairing damaged blades in the aerospace industry. The study showed that tensile fracture of the repaired TC17 interface specimen occurred in the as-deposit zone, with multiple dimples. They further revealed that the microstructure evolution in the middle stability zone changed from superfine to banded coarsened lamella  $\alpha$ . The microstructure shifts from a basket-weave in base metal to a fine needle  $\alpha$  phase near the fusing line in the HAZ. Therefore, there is a need to optimise the process parameter to tailor the microstructure during the repair of titanium-based alloys.

#### 3.2. Aluminium alloys

WAAM process is extensively applicable for manufacturing components using aluminium and its alloys. They have found immense usage in the aerospace (Gierth et al., 2020; Thapliyal, 2019; Zhai & Ma, 2016), marine (Vishnukumar et al., 2021) and automotive (Gierth et al., 2020; Murr et al., 2010; Thapliyal, 2019) industry due to its exceptional properties. The quality of the aluminium includes superior corrosion resistance, low density, high thermal conductivity, and good mechanical properties (Raut & Taiwade, 2021; Wu et al., 2018). Several WAAM techniques applicable to aluminium alloy deposition include GMAW (Gierth et al., 2020; Lakshminarayanan et al., 2009; Zhai & Ma, 2016) and GTAW (Lakshminarayanan et al., 2009). Vishnukumar *et al.* (2021) reported that CMT-based WAAM technology and ER4043 aluminium filler rejuvenated corroded AA5052 surfaces. This advancement overcomes the corrosion issues that marine-grade aluminium faces. The study focused on microstructure analysis, demonstrating WAAM's promise for corrosion-resistant aluminium repairs (Vishnukumar et al., 2021). However, an analysis of structural strength assessment needs attention. This analysis is critical, especially for the marine industry. There is a need to design a process that combines WAAM approaches with adaptive energy input



promises to improve aluminium repair efficacy, bridging the gap between restoration and structural integrity (Gierth et al., 2020).

### 3.3. Nickel-based alloys

Nickel-based superalloys are widely used in aerospace (Uriondo et al., 2015), high-temperature applications (Bewlay et al., 2004), corrosion resistance (in petrochemical) (Lu & Zangari, 2002), and marine sectors due to their exceptional strength, fatigue strength, tensile strength, and oxidation resistance at temperatures exceeding 550°C. Several nickel-based superalloys, such as Inconel 718 (Seow et al., 2019) and Inconel 625 (Tanvir et al., 2020) alloy, have been studied after WAAM processing. Ravi *et al.* (2020) used the GMAW process to produce the Inconel 625 product, and the specimen revealed a microstructure with some intermetallic phases and a columnar structure. Other techniques, such as PAW (Xu et al., 2013) and GTAW (J. F. Wang et al., 2016) have applications in the WAAM deposition process of nickel-based alloy. Since Ni-based alloys are common in the industry, investigations of Monel alloy and Ni-Cu-based alloys for WAAM repair are ongoing. The study aims to exploit their superior properties for applicability in the chemical, oil, and maritime industries, especially for producing drill collars, valves, and turbines (Marenych et al., 2021). Marenych *et al.* (2021) used a variety of heat treatment processes that were consistent with industry standards (DEF STAN 02-771) to demonstrate repair feasibility while adhering to accepted practices. The study shows that a deposition speed (up to 500 mm/min) caused higher strength and wear resistance for WAAM-produced nickel components. Hassel *et al.* (2020) reported that deposited materials at 45° to the build direction had higher strength but limited elongation than other build directions. This deposition angle suits the application of the WAAM process during the repair of Nickel components.

### 3.4. Steel alloys

Steel alloys are widely utilised in most industrial applications such as marine (shipbuilding) (Chandrasekaran et al., 2020; Tomar et al., 2022), automotive (automobile) (Guo & Leu, 2013), gas, construction, tools and moulds (Campatelli et al., 2021; Hu et al., 2017; Yan, 2013). The WAAM process may reduce production costs for all components manufactured, repaired or coated for steel alloys (Haden et al., 2017). For example, Hu *et al.* (2017) have shown that WAAM can rejuvenate 5CrNiMo hot forging dies and maintain their exceptional properties, such as hardness, high strength and wear resistance during application. Given the limited lifespan of these dies, WAAM has emerged as a popular approach for the critical duty of remanufacturing and repairing them (Hu et al., 2017). Several researches have been reported on the use of WAAM in repair, remanufacturing and refurbishment of complex parts made from steel and its alloys for several applications (Campatelli et al., 2021; Ghafoori et al., 2023; Lee et al., 2022). Hence, this technique forms the basis for the future manufacturing industries.

### 3.5. Bi-metallic materials

Bimetallic components are formed by fusing two different metals, each chosen for unique properties. The idea is to have a single structure with combined properties (Bandyopadhyay et al., 2022; Squires et al., 2023). The bimetallic additively manufactured structure appears as a potent solution for metal repair when using WAAM in simultaneous or sequential techniques (Ahsan et al., 2020). Researchers have investigated a wide range of bimetallic processes, including low carbon steels to SS316L (Ahsan et al., 2020), steel to nickel alloy (Wu et al., 2020), steel to copper functionally graded materials (Rodrigues et al., 2022), and steel to bronze (L. Liu et al., 2013). The studies intend to create innovative materials that a single material cannot provide. The material should have remarkable mechanical, physical, and thermal resistance capabilities for wide industrial applications. Liu *et al.* (2013) reported remarkable findings from GMAW deposition of steel (ER70S6) and bronze (SG-CuSi3). Their findings highlight strong metallurgical bonding and flawless adhesion at the interface layer free of defects (Raut & Taiwade, 2021). This study gave insights into the remanufacturing and repair, resulting in more dependable solutions. Bimetallic components, as demonstrated by their widespread use in aerospace (Wu et al., 2018), have the potential to regenerate parts with exceptional accuracy and resilience. WAAM's accuracy and controlled energy input make it possible to create tightly bonded bimetallic structures with particular properties. WAAM, due to its versatility, is an ideal avenue for repairing bimetallic components, ensuring they have the required qualities across numerous industries.

## 4. Process parameter Optimisation

WAAM-repaired components' qualities are affected by process parameters, so there is a need to optimise the process parameters. The product quality affected include surface shape, mechanical characteristics, and microstructure uniformity. Process parameters optimization such as feed rate, travel speed, voltage, current, and inter-pass temperature is paramount (I. S. Kim et al., 2003; Montgomery, 2017; S. Srivastava & Garg, 2017; Xia et al., 2021). Li *et al.* (2022) exhaustively reviewed the effect of different processes on the mechanical properties, bead geometry, surface roughness and microstructure. Several optimisation strategies have been investigated, including Full Factorial design (I. S. Kim et al., 2003), Response Surface Methodology (RSM) (S. Srivastava & Garg, 2017), Taguchi method (Tarng et al., 2002; Xia et al., 2021), and Artificial Neural Networks (ANN) (Andersen et al., 1990; Di et al., 1999; K. C. Kim & Maev, 2004). The studies show that a preferred technique depends on the specific requirements and constraints of the optimisation. The optimisation techniques used have their advantages and disadvantages. Full-factorial design carefully investigates all conceivable parameter combinations. This technique offers a thorough understanding of the parameter's impacts. However, this optimisation technique is costly and

time-consuming for analysing a range of process parameters (Kim et al., 2003). RSM is handy for simulating intricate interactions between input and output parameters. After establishing an early understanding of the process, RSM can efficiently lead to parameter modifications (S. Srivastava & Garg, 2017). Taguchi's Design of the Experiment is effective at dealing with noisy data and quickly identifying the most influential characteristics and most effective for experiments (Tarnag et al., 2002; Xia et al., 2021). ANN can recognise complex nonlinear correlations and patterns in data. They are particularly beneficial when the process is too complex to model using traditional methods (Andersen et al., 1990; Di et al., 1999; K. C. Kim & Maev, 2004). However, there is limited research on the application of these optimisation tools expressly for repairs. Process parameter optimization is critical in repairing. Optimal process parameters ensure resource efficiency, consistency, improved performance, and cost savings, as well as decreasing waste, enhancing repeatability, increasing product quality, and speeding up the production process.

## 5. Property characterisation of WAAM 3D printed parts

The property-structure analysis of structural components is necessary. This evaluation ensures the improvement of the WAAM printed parts' quality. The component performance analysis during service provides information that is necessary for design. This information on component safety and structural integrity contributes to a platform for later design stages. WAAM printed parts are prone to several challenges, such as residual stress, porosity, and delamination due to heat accumulation during production. Therefore, parts exposed to extreme conditions are affected by these defects that may cause failure. Repairing or remanufacturing components via WAAM necessitates precise quantification and procedural precision. As illustrated, cases where properties remained unquantified before and after deposition may jeopardize the endeavour (Schroepfer et al., 2017). As a result, a variety of methodologies presented by experts, as well as critical tests, merit detailed investigation within this work.

### 5.1. Residual Stress

The intricate thermal histories that WAAM components accumulate impede their proliferation, resulting in residual stress generation and part distortion (Xia et al., 2021). Residual stress significantly impacts material performance and component lifespan, causing negative consequences. In severe environments, the combination of residual stress and high temperatures or loads can cause fatigue strength to decrease, Stress Corrosion Cracking (SCC) to occur, and creep cracking resistance to increase (K. C. Kim & Maev, 2004). The evaluation of relative stress is critical because it has practical implications for component serviceability, security, and dependability. This significance links residual stress and a range of engineering errors and disasters (Fairfax & Steinzig, 2016; Radaj, 1990). Residual stresses (RS) are natural stresses enclosed inside an unburdened part at equilibrium. The interaction between these self-balancing stresses and the part performance, especially fatigue resilience, is determined by their amplitude, polarity, and dispersion in the presence of external pressures (Elsheikh et al., 2022). Heat treatment, cold working, machining, and flow localisation due to non-uniform plastic deformation can all cause RS. Thermal RS forms due to uneven thermal cycles during heating or cooling. Notably, the research is more concerned with the tensile nature of deposited layer RS and the compressive nature of substrate RS, which is an important consideration when considering WAAM-based component restoration (Colegrove et al., 2013; S. Srivastava et al., 2021). The overall performance of the components largely depends on RS levels and distributions (Maranhão & Davim, 2012).

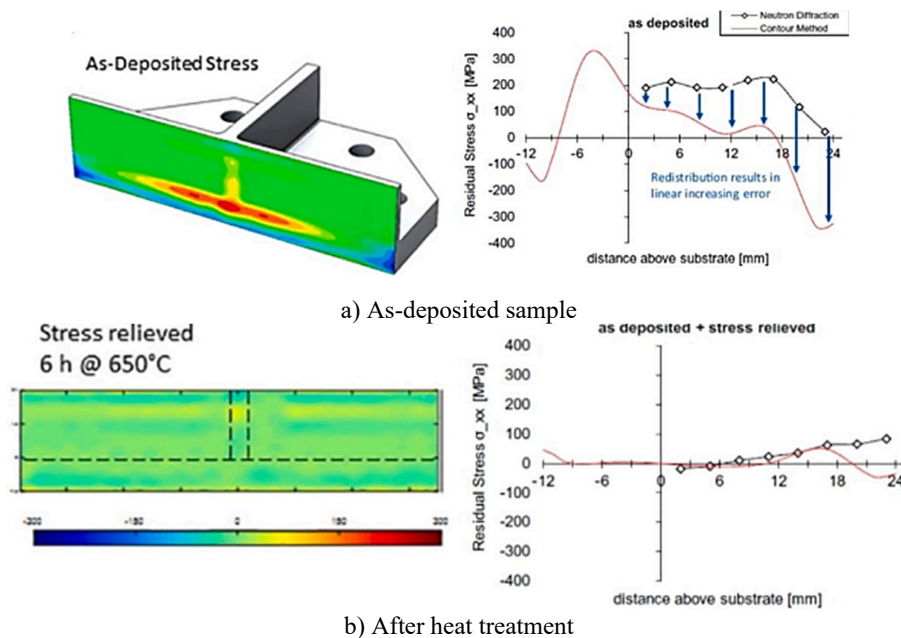

Fig. 10. Residual stress of WAAM deposited TC4 components (Lin et al., 2021).

The RS investigation employs a variety of methods, including neutron diffraction (GUO et al., 2021; Rossini et al., 2012; Szost et al., 2016), contour method (Martina et al., 2014), hole drilling strain gauge (ASTM, 2008; GUO et al., 2021), and x-ray diffraction (GUO et al., 2021; Pant, 2020; Withers & Bhadeshia, 2001). In non-destructive laboratory assessment, X-ray diffraction stands as a preferred choice due to its exceptional precision (GUO et al., 2021). Hönnige *et al.* (Hönnige et al., 2018) used the contour approach and neutron diffraction to reveal residual stress intricacies in WAAM-deposited titanium alloy (Ti-6Al-4V). Thermal cycles induced significant tensile strains in the substrate, outshining deposited layers in

Fig. 10a (Hönnige et al., 2018). However, stress normalization ran through the layers, ending in compressive stresses.

Fig. 10b depicts post-heat treatment choreographed stress harmony, demonstrating its potential as a solution for refurbished and repaired components, depending on application criteria. This result shows the residual stress distribution in the repair of broken parts across various material grades.

### 5.2. Microhardness analysis

WAAM produces components with different anisotropic material properties, having lower strength along the construction axis than in other directions. Notably, hardness increases inversely with decreasing grain size along the construction direction (Kapil et al., 2022). During repair efforts, the hardness of the deposited material varies, being lower near the substrate and gradually increasing in the upper layers (Kapil et al., 2022). The Vickers micro-hardness testing machine, which adhered to ASTM E384-17 (ISO/ASTM International, 2017) for standard testing and ASTM E3-11 (ASTM, 1995) for sample preparation, evaluated the hardness of repaired components across 10 - 15 s loading durations (Shim et al., 2021; Shojaati et al., 2020). Campatelli *et al.* (2021) evaluated the mending efficacy, confirming that the restored component's hardness was comparable to that of the original piece. These tests were carried out on an AISI H13 tool steel mould (Campatelli et al., 2021). Marenych *et al.* (2021) suggested the potential of cross-sectional temperature gradient heat treatment to standardise features across the component's cross-section following repair. In support of this, the deposition hardness after heat treatment exceeded the value of the as-received component by 22-32% (Marenych et al., 2021). Eimer *et al.* (2021), focused on diverse substrate aluminium alloys. The micro-hardness distribution revealed that the hardness of the deposited material was consistently measured lower than that of the substrate. Notably, instances arose where this discrepancy was mitigated or eliminated through heat treatment, particularly in cases where the substrate and wire are of the same alloy composition. Figure 11 illustrates the micro-hardness distributions of distinct aluminium alloys before and after heat treatment (Eimer et al., 2021).

### 5.3. Tensile analysis

The investigations on the TC17 titanium alloy repaired by WAAM by Zhuo showed that the ultimate strength of the interface specimen can reach 88.2% of the substrate material. The elongation was slightly lower than the substrate performed on the tensile testing machine with a maximum load of 50kN at a 1.5 mm/min displacement rate (Zhuo et al., 2020). The study was limited to laboratory-scale experiments, and its feasibility in using WAAM technology to repair aerospace industry blades needs verification through practical applications. The tensile tests on the WAAM of the dissimilar joint (RMD248 and ERNiCr-3) were necessary to test the feasibility of the WAAM repair mechanism of dissimilar materials. The results showed higher ultimate tensile strength and better comprehensive mechanical properties at lower welding speeds (Xia et al., 2021). Reports on the tensile testing of the AM metal repairs using various universal testing machines and the ASTM E8/E8M (ASTM E8, 2010) are available in the literature (Balit et al., 2020; Shim et al., 2021; Shojaati et al., 2020; Zhuo et al., 2020). The tensile characteristics of repaired 3D-printed walls under monotonic tensile testing are discussed by Balit *et al.* (2020). The printed specimens exhibited anisotropic behaviour. The yield and ultimate tensile strength of specimens loaded along the printing direction outperformed those loaded perpendicular to the printing orientations. The restored specimens' tensile strength lies between the substrate and a fully printed specimen loaded perpendicular to the printed direction (Balit et al., 2020). Therefore, the deposition strategy will ensure that the produced product has homogeneous mechanical properties.

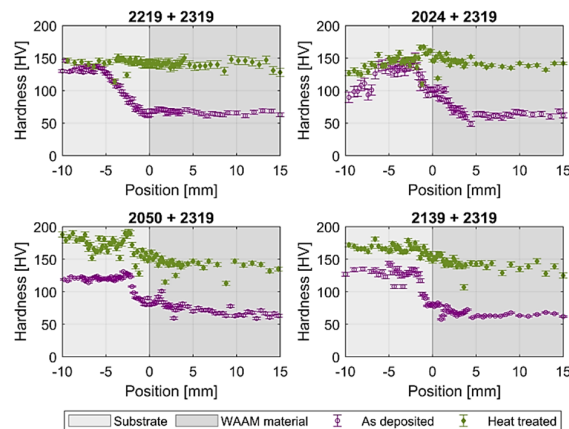
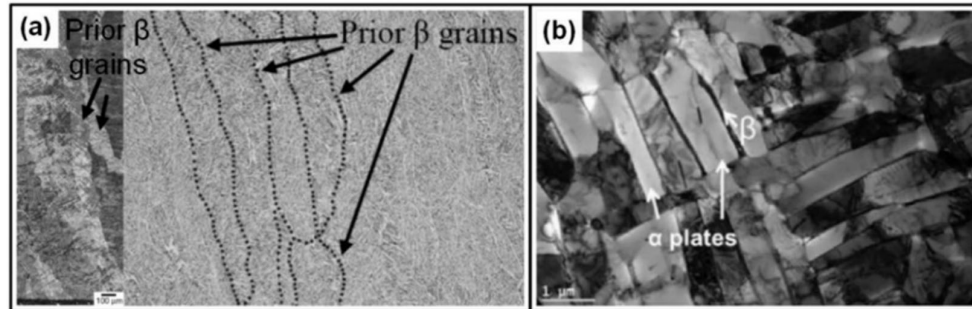

Fig. 11. Hardness profile before and after heat treatment for each aluminium alloy (Eimer et al., 2021).

### 5.5. Micrographic analysis

Xia *et al.* (2021) investigated the effect of welding speed on the microstructure of dissimilar joints RMD 248 and ERNiCr-3. This study provides information on component repair, whereby the exact material for damaged material is not readily available. The investigation of the welded area using a scanning electron microscope shows that at lower welding speeds, the microstructure of RMD248 had more retained austenite, while ERNiCr-3, a finer columnar crystal structure at higher welding speeds (Xia *et al.*, 2021). To further support the conclusions, the study should incorporate a range of welding conditions on various materials. For example, strength and homogeneity of mechanical properties are crucial for repairing titanium alloy components using WAAM. Large grains affect the overall performance of WAAM printed parts (Lin *et al.*, 2021).



**Fig. 12.** Primary microstructure of WAAM printed titanium components (Lin *et al.*, 2021): (a) Prior  $\beta$  columnar grains, (b)  $\alpha$  plates.

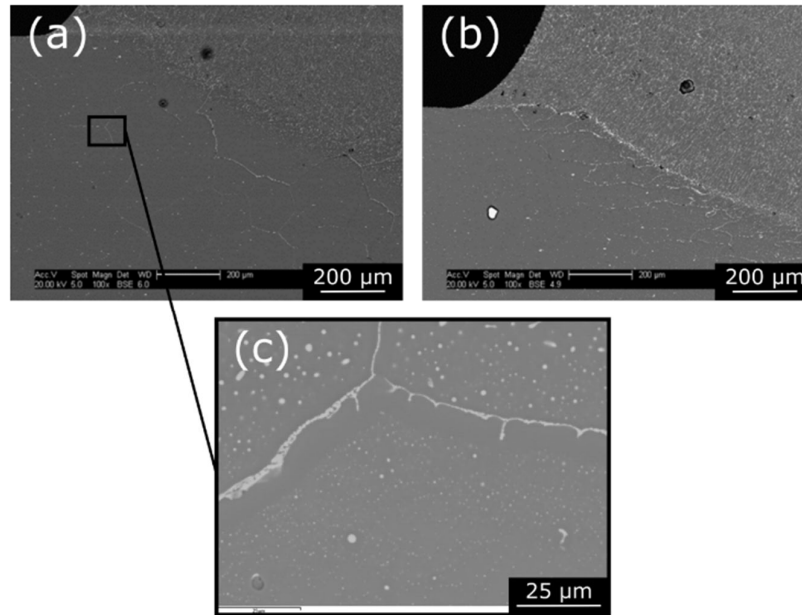

**Fig. 13.** SEM images of the partially melted zone in the aluminium alloy substrates (a) 2139 and (b) 2050 at low magnification, and the substrate (c) 2139 at higher magnification (Eimer *et al.*, 2021).

Generally, WAAM printed components have a coarse columnar grain microstructure due to successive re-melting and solidification heat cycles (Lin *et al.*, 2021; Rodrigues *et al.*, 2019). The size of prior  $\beta$  columnar grains (Fig. 12a) and  $\alpha$  plate thickness (Fig. 12b) are two key bases that indicate the strength and anisotropy of titanium components deposited by WAAM (Carroll *et al.*, 2015). Inter-pass rolling resulted in significant  $\beta$  grain refinement, a reduction in phase lamellae overall thickness, and a change in microstructure from highly columnar to equiaxed grains, thus improving mechanical properties (Martina *et al.*, 2015). Regardless of the substrate alloy or temper employed, liquations occurred at the grain boundaries in the partially melted zone of the aluminium alloy samples, according to Eimer *et al.* (2021), as shown in Fig. 13. This phenomenon, however, was eliminated in most samples after heat treatment (Eimer *et al.*, 2021). The material characteristics between substrates and deposited layers are crucial in the repair mechanisms of different materials. Zhuo *et al.* (2020) investigated the microstructure evolution of TC17 titanium alloy repaired by WAAM technology. The microstructure at the interface between the as-deposited and base metal showed that the size of  $\alpha$  phases for as-deposits was coarser and longer than the base metal. This phenomenon was caused by a higher content of  $\alpha$  stable elements in the as-deposited condition (Zhuo *et al.*, 2020).

Wang et al. (2023) carried out a microstructure and defect evolution on WAAM of AA5356 components noting the properties of deposited layers and that of deposited layers. The investigation showed that the microstructure properties improved by adjusting the deposition angle to 90 degrees. The microporosity increased gradually from 1.23% to 1.75% with an increase in the deposition height (Wang et al., 2023). Techniques to reduce the porosity need further investigation. Microstructure evaluations of AM-repaired components are reported in the literature (Balit et al., 2020; Shim et al., 2021; Shojaati et al., 2020; Zhuo et al., 2020). Balit et al. (2020) investigated the microstructure parameters of 316L stainless steel specimens made or restored using Directed Energy Deposition. The microstructural investigation revealed elongated grains with process factors controlling their sizes, shapes, and preferred orientations. The study also examines the effect of microstructure orientation as affected by the loading direction on dissipative behaviour and micro-crack onset (Balit et al., 2020). The repair of Monel alloy components' microstructure and cross-sectional analysis revealed columnar grains in the fusion zone, heterogeneous epitaxial grains in the remelted zone, and single-phase FCC grains in base metal (Marenych et al., 2021). Vishnukumar et al. (2021) investigated the microstructure of WAAM-produced plates using CMT and CMT + Pulse (CMT + P) modes. The microstructure of CMT + P mode revealed fine equiaxed dendrites. WAAM-treated samples corroded at a rate equivalent to wrought counterparts (Vishnukumar et al., 2021). The microstructure of the restored component (**Fig. 14a**) changes drastically from the substrate to the outer deposited layer. A columnar structure is visible in the interfacial bonding area (**Fig. 14b**) due to rapid cooling, which is common in additive manufacturing. As the structure progresses to the middle layers (**Fig. 14c**), it becomes dendritic with interdendritic eutectics due to slower solidification. The outermost layers (**Fig. 14d**), which experienced slower cooling, had an equiaxed structure with fewer dendrites (Zhang, Cui, et al., 2019). Table 4 shows some of the characterisation techniques researchers use to evaluate the properties of WAAM-repaired components for various materials used for industrial applications.

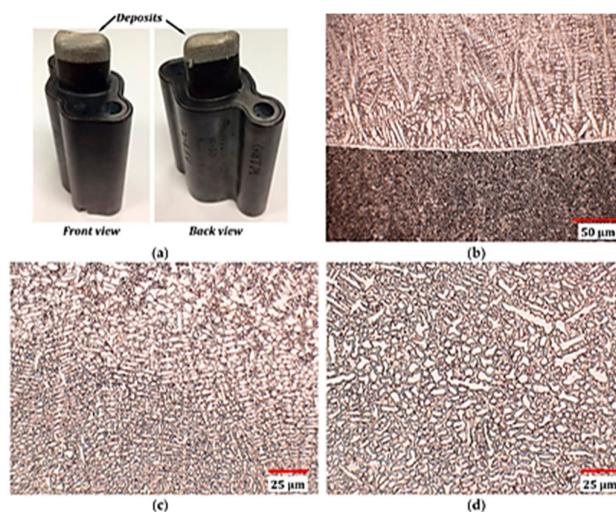

**Fig. 14.** (a) Repaired component and Optical images (b) the interface, (c) the middle layers, (d) the top layers (X. Zhang, Cui, et al., 2019).

**Table 4.** Summary of WAAM in repair, remanufacturing and refurbishment of components.

Method	Material	Property analysed	Application	Refs
CMT	Mild steel S355J2 + N substrate, ER70S-6 filler wire	Residual stress, microstructure, Surface strain, Fractography	buildings, bridges	(Ghafoori et al., 2023)
MIG, CMT	Grey cast iron ISO 185/JL/250 substrate A5.14 ERNi-1 filler wire	Hardness, microstructure, bead geometry	rail repair and enhancing	(Lee et al., 2022)
GMAW	X20Cr13 steel substrate, ER 410NiMo filler wire	Hardness, tensile, impact toughness	manufacturing gas turbines	(Shojaati et al., 2020)
CMT	AISI H13 steel substrate	Hardness, microstructure	die casting moulds,	(Campatelli et al., 2021)
GMAW	Nickel (Monel) alloy	Hardness, microstructure	marine, chemical, and oil extraction industries	(Marenych et al., 2021)
GTAW	Titanium (TC17 plate- TC11 filler wire) alloys	Tensile, microstructure	compressor blades and blisk in the aerospace industry	(Zhuo et al., 2020)
CMT	Steels	Microstructure, bead geometry	impellers, turbine blades, and machine tools, moulds,	(Baffa et al., 2022)
CMT	Aluminium alloys; AA5052 substrate, ER4043 filler wire	Microstructure, Corrosion rate/ Wear	marine applications where it is exposed to seawater regularly	(Vishnukumar et al., 2021)
GMAW	Steels Q235 substrate, H08Mn2Si filler wire	Bead geometry	impellers, turbine blades, and machine tools, moulds	(Y. Li et al., 2019b)
CMT	Mild steel substrate, Stainless Steel 304 filler wire	Bead geometry	-----	(Sarathchandra et al., 2020)



## 6. Conclusions and future directions

WAAM process has provided a tool for agile manufacturing for future industrial production of structural and functional components. The reliability of this technique is due to its versatile application in the production and remanufacturing of complex shapes. This method has a high deposition rate and low geometrical restraints. Hence, the method is suitable for manufacturing and repairing large-scale components. The review article reports a comprehensive review of the feasibility of the WAAM process in the remanufacturing process of structural and functional parts. The main aspects of this review and future directions are as follows:

1. There is a need for tool path optimisation during repair, remanufacture and refurbishment of components using WAAM. Optimised tool path will ensure better dimensional accuracy, thus minimising post-processing.
2. There is a need to integrate an adaptive parameter control system into Wire Arc Additive Manufacturing (WAAM). This system will allow manufacturing components with distinct properties for each layer and per-distance basis from the central position. This method matches properties to the operational requirements of the manufactured product. The control system will transform repair potential using the WAAM process by allowing the modification of components to suit a particular application, thus improving the product life and performance.
3. The applicability of WAAM in the manufacturing or repairing of wide-material systems is of great concern. This information is necessary to understand the response of different materials during deposition, hence determining compatibility and detecting potential problems during the WAAM process.
4. In-depth microstructural studies could provide insights into the metallurgical changes occurring during the WAAM process. The study will provide information on grain growth, phase transitions, and potential flaw formation during manufacturing. Hence, evaluating the effect of process parameters on the overall performance of the component repaired using WAAM is paramount.
5. Hybrid manufacturing technologies, such as WAAM and traditional machining processes or other additive manufacturing techniques, have the potential to provide creative solutions for repairs and remanufacturing challenges.
6. Feasibility of WAAM components Concentrating on real-world industrial applications, such as aerospace, automotive, or energy, could validate the feasibility, cost-effectiveness, and efficacy of WAAM repairs in real-world circumstances.
7. Standard procedures and recommendations for WAAM repair techniques urgently need to be developed to guide future industrial production processes.

## References

- Acharya, R., & Das, S. (2015). Additive Manufacturing of IN100 Superalloy Through Scanning Laser Epitaxy for Turbine Engine Hot-Section Component Repair: Process Development, Modeling, Microstructural Characterization, and Process Control. *Metallurgical and Materials Transactions A: Physical Metallurgy and Materials Science*, 46(9), 3864–3875. <https://doi.org/10.1007/s11661-015-2912-6>
- Ahn, D. G. (2021). Directed Energy Deposition (DED) Process: State of the Art. In *International Journal of Precision Engineering and Manufacturing - Green Technology* (Vol. 8, Issue 2). Korean Society for Precision Engineering. <https://doi.org/10.1007/s40684-020-00302-7>
- Ahsan, M. R. U., Tanvir, A. N. M., Ross, T., Elsaywy, A., Oh, M. S., & Kim, D. B. (2020). Fabrication of bimetallic additively manufactured structure (BAMS) of low carbon steel and 316L austenitic stainless steel with wire + arc additive manufacturing. *Rapid Prototyping Journal*, 26(3), 519–530. <https://doi.org/10.1108/RPJ-09-2018-0235>
- Albannai, A. I. (2022). A Brief Review on The Common Defects in Wire Arc Additive Manufacturing ( Review Paper ). *International Journal of Current Science Research and Review*, 05(12), 4556–4576. <https://doi.org/10.47191/ijcsrr/V5-i12-19>
- Alberti, E. A., Bueno, B. M. P., & D'Oliveira, A. S. C. M. (2016). Additive manufacturing using plasma transferred arc. *The International Journal of Advanced Manufacturing Technology*, 83(9), 1861–1871. <https://doi.org/10.1007/s00170-015-7697-7>
- Aldalur, E., Veiga, F., Suárez, A., Bilbao, J., & Lamikiz, A. (2020). Analysis of the wall geometry with different strategies for high deposition wire arc additive manufacturing of mild steel. *Metals*, 10(7), 1–19. <https://doi.org/10.3390/met10070892>
- Andersen, K., Cook, G. E., Karsai, G., & Ramaswamy, K. (1990). Artificial Neural Networks Applied to Arc Welding Process Modeling and Control. *IEEE Transactions on Industry Applications*, 26(5), 824–830. <https://doi.org/10.1109/28.60056>
- Artaza, T., Suárez, A., Murua, M., García, J. C., Taberero, I., & Lamikiz, A. (2019). Wire arc additive manufacturing of Mn4Ni2CrMo steel: Comparison of mechanical and metallographic properties of PAW and GMAW. *Procedia Manufacturing*, 41, 1071–1078. <https://doi.org/10.1016/j.promfg.2019.10.035>
- Artaza, T., Suárez, A., Veiga, F., Braceras, I., Taberero, I., Larrañaga, O., & Lamikiz, A. (2020). Wire arc additive manufacturing Ti6Al4V aeronautical parts using plasma arc welding: Analysis of heat-treatment processes in different atmospheres. *Journal of Materials Research and Technology*, 9(6), 15454–15466.

- <https://doi.org/10.1016/J.JMRT.2020.11.012>
- ASTM. (1995). *Designation: E3-95. Standard Practice for Preparation of Metallographic Specimens* (p. 8). ASTM.
- ASTM. (2008). Determining Residual Stresses by the Hole-Drilling Strain-Gage Method. *Standard Test Method E837-13a*, 1–16. <http://scholar.google.com/scholar?hl=en&btnG=Search&q=intitle:Standard+Test+Method+for+Determining+Residual+Stresses+by+the+Hole-Drilling+Strain-#0>
- ASTM E8. (2010). ASTM E8/E8M standard test methods for tension testing of metallic materials 1. *Annual Book of ASTM Standards 4, C*, 1–27. <https://doi.org/10.1520/E0008>
- Attaran, M. (2017). The rise of 3-D printing: The advantages of additive manufacturing over traditional manufacturing. *Business Horizons*, 60(5), 677–688. <https://doi.org/10.1016/j.bushor.2017.05.011>
- Babu, S. S., Love, L., Dehoff, R., Peter, W., Watkins, T. R., & Pannala, S. (2015). *Additive manufacturing of materials: Opportunities and challenges*. 40(December), 1154–1161. <https://doi.org/10.1557/mrs.2015.234>
- Baffa, F., Venturini, G., Campatelli, G., & Galvanetto, E. (2022). Effect of stepover and torch tilting angle on a repair process using WAAM. *Advances in Manufacturing*, 10(4), 541–555. <https://doi.org/10.1007/s40436-022-00393-2>
- Bai, X., Colegrove, P., Ding, J., Zhou, X., Diao, C., Bridgeman, P., roman Hönnige, J., Zhang, H., & Williams, S. (2018). Numerical analysis of heat transfer and fluid flow in multilayer deposition of PAW-based wire and arc additive manufacturing. *International Journal of Heat and Mass Transfer*, 124, 504–516. <https://doi.org/10.1016/j.ijheatmasstransfer.2018.03.085>
- Balashanmugam, N. (2021). Chapter 7 - Perspectives on additive manufacturing in Industry 4.0. In M. Manjaiah, K. Raghavendra, N. Balashanmugam, & J. P. B. T.-A. M. Davim (Eds.), *Woodhead Publishing Reviews: Mechanical Engineering Series* (pp. 127–150). Woodhead Publishing. <https://doi.org/10.1016/B978-0-12-822056-6.00001-1>
- Balit, Y., Joly, L. R., Szmytka, F., Durbecq, S., Charkaluk, E., & Constantinescu, A. (2020). Self-heating behavior during cyclic loadings of 316L stainless steel specimens manufactured or repaired by Directed Energy Deposition. *Materials Science and Engineering A*, 786. <https://doi.org/10.1016/j.msea.2020.139476>
- Bandyopadhyay, A., Zhang, Y., & Onuikwe, B. (2022). Additive manufacturing of bimetallic structures. *Virtual and Physical Prototyping*, 17(2), 256–294. <https://doi.org/10.1080/17452759.2022.2040738>
- Barath Kumar, M. D., & Manikandan, M. (2022). Assessment of Process, Parameters, Residual Stress Mitigation, Post Treatments and Finite Element Analysis Simulations of Wire Arc Additive Manufacturing Technique. In *Metals and Materials International* (Vol. 28, Issue 1). The Korean Institute of Metals and Materials. <https://doi.org/10.1007/s12540-021-01015-5>
- Behera, A. (2020). Processes and Application in Additive Manufacturing: Practices in Aerospace, Automobile, Medical, and Electronic Industries. In *Additive Manufacturing applications for metals and composites* (pp. 25–47). IGI Global.
- Bennett, J., Dudas, R., Cao, J., Ehmann, K., & Hyatt, G. (2016). Control of heating and cooling for direct laser deposition repair of cast iron components. *International Symposium on Flexible Automation, ISFA 2016*, 229–236. <https://doi.org/10.1109/ISFA.2016.7790166>
- Bewlay, B. P., Jackson, M. R., Subramanian, P. R., & Lewandowski, J. J. (2004). Very high-temperature Nb-silicide-based composites. *Proceedings of the International Symposium on Niobium for High Temperature Applications*, 34(October), 51–61.
- Bi, G., & Gasser, A. (2011). Restoration of nickel-base turbine blade knife-edges with controlled laser aided additive manufacturing. *Physics Procedia*, 12(PART 1), 402–409. <https://doi.org/10.1016/j.phpro.2011.03.051>
- Bourell, D. L. (2016). Perspectives on Additive Manufacturing. *Annual Review of Materials Research*, 46, 1–18. <https://doi.org/10.1146/annurev-matsci-070115-031606>
- Branza, T., Deschiaux-Beaume, F., Sierra, G., & Lours, P. (2009). Study and prevention of cracking during weld-repair of heat-resistant cast steels. *Journal of Materials Processing Technology*, 209(1), 536–547. <https://doi.org/10.1016/j.jmatprotec.2008.02.033>
- Caballero, A., Ding, J., Ganguly, S., & Williams, S. (2019). Wire + Arc Additive Manufacture of 17-4 PH stainless steel: Effect of different processing conditions on microstructure, hardness, and tensile strength. *Journal of Materials Processing Technology*, 268, 54–62. <https://doi.org/10.1016/j.jmatprotec.2019.01.007>
- Cagan, S. C., & Buldum, B. B. (2021). Machinability investigation of Incoloy 825 in high-speed turning under dry conditions. *Revista Materia*, 26(4). <https://doi.org/10.1590/S1517-707620210004.1366>
- Campatelli, G., Venturini, G., Grossi, N., Baffa, F., Scippa, A., & Yamazaki, K. (2021). Design and testing of a waam retrofit kit for repairing operations on a milling machine. *Machines*, 9(12). <https://doi.org/10.3390/machines9120322>
- Carroll, B. E., Palmer, T. A., & Beese, A. M. (2015). Anisotropic tensile behavior of Ti-6Al-4V components fabricated with directed energy deposition additive manufacturing. *Acta Materialia*, 87, 309–320. <https://doi.org/10.1016/j.actamat.2014.12.054>
- Chandrasekaran, S., Hari, S., & Amirthalingam, M. (2020). Wire arc additive manufacturing of functionally graded material for marine risers. *Materials Science and Engineering A*, 792, 139530. <https://doi.org/10.1016/j.msea.2020.139530>
- Chaturvedi, M., Scutelnicu, E., Rusu, C. C., Mistodie, L. R., Mihailescu, D., & Subbiah, A. V. (2021). Wire Arc Additive Manufacturing: Review on Recent Findings and Challenges in Industrial Applications and Materials Characterization. *Metals*, 11(6), 939. <https://doi.org/10.3390/met11060939>
- Clare, A. T., Oyelola, O., Abioye, T. E., & Farayibi, P. K. (2013). Laser cladding of rail steel with Co-Cr. *Surface Engineering*,

- 29(10), 731–736. <https://doi.org/10.1179/1743294412Y.0000000075>
- Colegrove, P. A., Coules, H. E., Fairman, J., Martina, F., Kashoob, T., Mamash, H., & Cozzolino, L. D. (2013). Microstructure and residual stress improvement in wire and arc additively manufactured parts through high-pressure rolling. *Journal of Materials Processing Technology*, 213(10), 1782–1791. <https://doi.org/10.1016/j.jmatprotec.2013.04.012>
- Cunningham, C. R., Flynn, J. M., Shokrani, A., Dhokia, V., & Newman, S. T. (2018). Invited review article: Strategies and processes for high quality wire arc additive manufacturing. *Additive Manufacturing*, 22, 672–686. <https://doi.org/10.1016/J.ADDMA.2018.06.020>
- Cunningham, C. R., Wikshåland, S., Xu, F., Kemakolam, N., Shokrani, A., Dhokia, V., & Newman, S. T. (2017). Cost Modelling and Sensitivity Analysis of Wire and Arc Additive Manufacturing. *Procedia Manufacturing*, 11(June 2017), 650–657. <https://doi.org/10.1016/j.promfg.2017.07.163>
- Dargusch, M. S. (2017). Metallurgical and geometrical characterisation of the 316L stainless steel clad deposited on a mild steel substrate. *Surface & Coatings Technology*. <https://doi.org/10.1016/j.surfcoat.2017.08.013>
- Dass, A., & Moridi, A. (2019). State of the art in directed energy deposition: From additive manufacturing to materials design. In *Coatings* (Vol. 9, Issue 7, p. 418). Multidisciplinary Digital Publishing Institute. <https://doi.org/10.3390/COATINGS9070418>
- DebRoy, T., Wei, H. L., Zuback, J. S., Mukherjee, T., Elmer, J. W., Milewski, J. O., Beese, A. M., Wilson-Heid, A., De, A., & Zhang, W. (2018). Additive manufacturing of metallic components – Process, structure and properties. *Progress in Materials Science*, 92, 112–224. <https://doi.org/10.1016/j.pmatsci.2017.10.001>
- Deng, F., Yang, G., Wu, B., Qin, L., Zheng, J., & Zhou, S. (2022). Microstructure and Mechanical Properties of Hybrid-Manufactured Maraging Steel Component Using 4% Nitrogen Shielding Gas Fabricated by Wrought-Wire Arc Additive Manufacturing. In *Coatings* (Vol. 12, Issue 3). <https://doi.org/10.3390/coatings12030356>
- Di, L., Chandel, R. S., & Srikanthan, T. (1999). Static modeling of GMAW process using artificial neural networks. *Materials and Manufacturing Processes*, 14(1), 13–35. <https://doi.org/10.1080/10426919908914802>
- Dias, M., Pragana, J. P. M., Ferreira, B., Ribeiro, I., & Silva, C. M. A. (2022). Economic and Environmental Potential of Wire-Arc Additive Manufacturing. *Sustainability (Switzerland)*, 14(9). <https://doi.org/10.3390/su14095197>
- Ding, D., Pan, Z., Cuiuri, D., & Li, H. (2014). A tool-path generation strategy for wire and arc additive manufacturing. *International Journal of Advanced Manufacturing Technology*, 73(1–4), 173–183. <https://doi.org/10.1007/s00170-014-5808-5>
- Ding, D., Pan, Z., Cuiuri, D., & Li, H. (2015). Wire-feed additive manufacturing of metal components: technologies, developments and future interests. *The International Journal of Advanced Manufacturing Technology*, 81(1), 465–481. <https://doi.org/10.1007/s00170-015-7077-3>
- Ding, J., Martina, F., & Williams, S. (2015). Production of large metallic components by additive manufacture – issues and achievements. *1st Metallic Materials and Processes: Industrial Challenges, November*.
- Dinovitser, M., Chen, X., Laliberte, J., Huang, X., & Frei, H. (2019). Effect of wire and arc additive manufacturing (WAAM) process parameters on bead geometry and microstructure. *Additive Manufacturing*, 26, 138–146. <https://doi.org/10.1016/J.ADDMA.2018.12.013>
- Diourté, A., Bugarin, F., Bordreuil, C., & Segonds, S. (2021). Continuous three-dimensional path planning (CTPP) for complex thin parts with wire arc additive manufacturing. *Additive Manufacturing*, 37, 101622. <https://doi.org/10.1016/j.addma.2020.101622>
- Eimer, E., Williams, S., Ding, J., Ganguly, S., & Chehab, B. (2021). Effect of substrate alloy type on the microstructure of the substrate and deposited material interface in aluminium wire + arc additive manufacturing. *Metals*, 11(6). <https://doi.org/10.3390/met11060916>
- Elgazzar, H., & Abdelghany, K. (2022). Recent Research Progress and Future Prospects in the Additive Manufacturing of Biomedical Magnesium and Titanium Implants. In *Additive and Subtractive Manufacturing Processes*. <https://doi.org/10.1201/9781003327394-8>
- Elsheikh, A. H., Shanmugan, S., Muthuramalingam, T., Thakur, A. K., Essa, F. A., Ibrahim, A. M. M., & Mosleh, A. O. (2022). A comprehensive review on residual stresses in turning. *Advances in Manufacturing*, 10(2), 287–312. <https://doi.org/10.1007/s40436-021-00371-0>
- Fairfax, E., & Steinzig, M. (2016). *A Summary of Failures Caused by Residual Stresses* (pp. 209–214). [https://doi.org/10.1007/978-3-319-21765-9\\_26](https://doi.org/10.1007/978-3-319-21765-9_26)
- Ford, S. (2016). *Additive manufacturing and sustainability: an exploratory study of the advantages and challenges*. 137. <https://doi.org/10.1016/j.jclepro.2016.04.150>
- Foster, J., Cullen, C., Fitzpatrick, S., Payne, G., Hall, L., & Marashi, J. (2019). Remanufacture of hot forging tools and dies using laser metal deposition with powder and a hard-facing alloy Stellite 21®. *Journal of Remanufacturing*, 9(3), 189–203. <https://doi.org/10.1007/s13243-018-0063-9>
- Frazier, W. E. (2014). Metal additive manufacturing: A review. In *Journal of Materials Engineering and Performance* (Vol. 23, Issue 6, pp. 1917–1928). <https://doi.org/10.1007/s11665-014-0958-z>
- Friel, R. J. (2015). Power ultrasonics for additive manufacturing and consolidating of materials. *Power Ultrasonics: Applications of High-Intensity Ultrasound*, 313–335. <https://doi.org/10.1016/B978-1-78242-028-6.00013-2>
- G.P., R., Kamaraj, M., & Bakshi, S. R. (2017). Hardfacing of AISI H13 tool steel with Stellite 21 alloy using cold metal transfer welding process. *Surface and Coatings Technology*, 326, 63–71. <https://doi.org/10.1016/j.surfcoat.2017.07.050>
- Gary S. Schajer, C. O. R. (2013). *Overview of Residual Stresses and Their Measurement*. 8(10), 2565–2567.

- Gasser, A., Backes, G., Kelbassa, I., Weisheit, A., & Wissenbach, K. (2010). Laser additive manufacturing: laser metal deposition (LMD) and selective laser melting (SLM) in turbo-engine applications. *Laser Material Processing*, 2, 58–63.
- Ge, J., Lin, J., Chen, Y., Lei, Y., & Fu, H. (2018). Characterization of wire arc additive manufacturing 2Cr13 part: Process stability, microstructural evolution, and tensile properties. *Journal of Alloys and Compounds*, 748, 911–921. <https://doi.org/10.1016/j.jallcom.2018.03.222>
- Geng, H., Li, J., Xiong, J., Lin, X., & Zhang, F. (2017). Optimization of wire feed for GTAW based additive manufacturing. *Journal of Materials Processing Technology*, 243, 40–47. <https://doi.org/10.1016/j.jmatprotec.2016.11.027>
- Ghafoori, E., Dahaghin, H., Diao, C., Pichler, N., Li, L., Mohri, M., Ding, J., Ganguly, S., & Williams, S. (2023). Fatigue strengthening of damaged steel members using wire arc additive manufacturing. *Engineering Structures*, 284(March), 115911. <https://doi.org/10.1016/j.engstruct.2023.115911>
- Gibson, I., Rosen, D., & Stucker, B. (2015a). 3D Printing, Rapid Prototyping, and Direct Digital Manufacturing. In *Additive Manufacturing Technologies*.
- Gibson, I., Rosen, D., & Stucker, B. (2015b). Additive manufacturing technologies: 3D printing, rapid prototyping, and direct digital manufacturing, second edition. *Additive Manufacturing Technologies: 3D Printing, Rapid Prototyping, and Direct Digital Manufacturing, Second Edition, Dmd*, 1–498. <https://doi.org/10.1007/978-1-4939-2113-3>
- Gierth, M., Henckell, P., Ali, Y., Scholl, J., & Bergmann, J. P. (2020). Wire Arc Additive Manufacturing (WAAM) of aluminum alloy AlMg5Mn with energy-reduced Gas Metal Arc Welding (GMAW). *Materials*, 13(12), 1–22. <https://doi.org/10.3390/ma13122671>
- Gornet, T. (2017). *History of Additive Manufacturing*. 1–24. <https://doi.org/10.4018/978-1-5225-2289-8.ch001>
- Gorsse, S., Hutchinson, C., Gouné, M., & Banerjee, R. (2017). Additive manufacturing of metals: a brief review of the characteristic microstructures and properties of steels, Ti-6Al-4V and high-entropy alloys. *Science and Technology of Advanced Materials*, 18(1), 584–610. <https://doi.org/10.1080/14686996.2017.1361305>
- Graf, B., Gumenyuk, A., & Rethmeier, M. (2012). Laser Metal Deposition as Repair Technology for Stainless Steel and Titanium Alloys. *Physica Procedia*, 39, 376–381. <https://doi.org/10.1016/j.phpro.2012.10.051>
- GUO, J., FU, H., PAN, B., & KANG, R. (2021). Recent progress of residual stress measurement methods: A review. *Chinese Journal of Aeronautics*, 34(2), 54–78. <https://doi.org/10.1016/j.cja.2019.10.010>
- Guo, N., & Leu, M. C. (2013). Additive manufacturing: Technology, applications and research needs. *Frontiers of Mechanical Engineering*, 8(3), 215–243. <https://doi.org/10.1007/s11465-013-0248-8>
- Haden, C. V., Zeng, G., Carter, F. M., Ruhl, C., Krick, B. A., & Harlow, D. G. (2017). Wire and arc additive manufactured steel: Tensile and wear properties. *Additive Manufacturing*, 16, 115–123. <https://doi.org/10.1016/j.addma.2017.05.010>
- Hassel, T., & Carstensen, T. (2020). Properties and anisotropy behaviour of a nickel base alloy material produced by robot-based wire and arc additive manufacturing. *Welding in the World*, 64(11), 1921–1931. <https://doi.org/10.1007/s40194-020-00971-7>
- Hawaldar, N., & Zhang, J. (2018). A comparative study of fabrication of sand casting mold using additive manufacturing and conventional process. *International Journal of Advanced Manufacturing Technology*, 97(1–4), 1037–1045. <https://doi.org/10.1007/s00170-018-2020-z>
- Hönnige, J. R., Colegrove, P. A., Ahmad, B., Fitzpatrick, M. E., Ganguly, S., Lee, T. L., & Williams, S. W. (2018). Residual stress and texture control in Ti-6Al-4V wire + arc additively manufactured intersections by stress relief and rolling. *Materials and Design*, 150(2017), 193–205. <https://doi.org/10.1016/j.matdes.2018.03.065>
- Hu, Z., Qin, X., & Shao, T. (2017). Welding Thermal Simulation and Metallurgical Characteristics Analysis in WAAM for 5CrNiMo Hot Forging Die Remanufacturing. *Procedia Engineering*, 207, 2203–2208. <https://doi.org/10.1016/j.proeng.2017.10.982>
- ISO/ASTM International. (2017). Designation: E384-17 Standard Test Method for Microindentation Hardness of Materials. *The Biology of the Xenarthra*, 281–293. <https://doi.org/10.1520/E0384-17>
- Ivanova, O., Williams, C., & Campbell, T. (2013). Additive manufacturing (AM) and nanotechnology: Promises and challenges. *Rapid Prototyping Journal*, 19(5), 353–364. <https://doi.org/10.1108/RPJ-12-2011-0127>
- Ivántabernero, Paskual, A., Alvarez, P., & Suárez, A. (2018). Study on Arc Welding Processes for High Deposition Rate Additive Manufacturing. *Procedia CIRP*, 68, 358–362. <https://doi.org/10.1016/j.procir.2017.12.095>
- Javid, M., & Haleem, A. (2019). Current status and applications of additive manufacturing in dentistry: A literature-based review. *Journal of Oral Biology and Craniofacial Research*, 9(3), 179–185. <https://doi.org/10.1016/j.jobcr.2019.04.004>
- Kanishka, K., & Acherjee, B. (2023). A systematic review of additive manufacturing-based remanufacturing techniques for component repair and restoration. *Journal of Manufacturing Processes*, 89, 220–283. <https://doi.org/https://doi.org/10.1016/j.jmapro.2023.01.034>
- Kapil, S., Joshi, P., Kulkarni, P. M., Negi, S., Kumar, R., & Karunakaran, K. P. (2018). Elimination of support mechanism in additive manufacturing through substrate tilting. *Rapid Prototyping Journal*, 24(7), 1155–1165. <https://doi.org/10.1108/RPJ-07-2017-0139>
- Kapil, S., Kulkarni, P., Joshi, P., Negi, S., & Karunakaran, K. P. (2019). Retrofitment of a CNC machine for omni-directional tungsten inert gas cladding. *Virtual and Physical Prototyping*, 14(3), 293–306. <https://doi.org/10.1080/17452759.2018.1552484>
- Kapil, S., Rajput, A. S., & Sarma, R. (2022). Hybridization in wire arc additive manufacturing. *Frontiers in Mechanical Engineering*, 8(September), 1–19. <https://doi.org/10.3389/fmech.2022.981846>
- Karpagaraj, A., Baskaran, S., Arunnellaiappan, T., & Kumar, N. R. (2020). A review on the suitability of wire arc additive

- manufacturing (WAAM) for stainless steel 316. *AIP Conference Proceedings*, 2247(July). <https://doi.org/10.1063/5.0004148>
- Karunakaran, K. P., Suryakumar, S., Pushpa, V., & Akula, S. (2009). Retrofitment of a CNC machine for hybrid layered manufacturing. *International Journal of Advanced Manufacturing Technology*, 45(7–8), 690–703. <https://doi.org/10.1007/s00170-009-2002-2>
- Kim, I. S., Son, K. J., Yang, Y. S., & Yarangada, P. K. D. V. (2003). Sensitivity analysis for process parameters in GMA welding processes using a factorial design method. *International Journal of Machine Tools and Manufacture*, 43(8), 763–769. [https://doi.org/10.1016/S0890-6955\(03\)00054-3](https://doi.org/10.1016/S0890-6955(03)00054-3)
- Kim, K. C., & Maev, R. G. (2004). Neural network analysis for evaluating welding process. *Key Engineering Materials*, 270–273(III), 2357–2364. <https://doi.org/10.4028/www.scientific.net/kem.270-273.2357>
- Koehler, H., Partes, K., Seefeld, T., & Vollertsen, F. (2010). Laser reconditioning of crankshafts: From lab to application. *Physics Procedia*, 5(PART 1), 387–397. <https://doi.org/10.1016/j.phpro.2010.08.160>
- Köhler, M., Fiebig, S., Hensel, J., & Dilger, K. (2019). Wire and arc additive manufacturing of aluminum components. *Metals*, 9(5), 1–9. <https://doi.org/10.3390/met9050608>
- Koli, Y., Arora, S., Ahmad, S., Priya, Yuvaraj, N., & Khan, Z. A. (2023). Investigations and Multi-response Optimization of Wire Arc Additive Manufacturing Cold Metal Transfer Process Parameters for Fabrication of SS308L Samples. *Journal of Materials Engineering and Performance*, 32(5), 2463–2475. <https://doi.org/10.1007/s11665-022-07282-6>
- Kozamernik, N., & Bra, D. (2020). *WAAM system with interpass temperature control and forced cooling for near-net-shape printing of small metal components*. 1955–1968.
- Krishna, R., Manjaiah, M., & Mohan, C. B. (2021). Chapter 3 - Developments in additive manufacturing. In M. Manjaiah, K. Raghavendra, N. Balashanmugam, & J. P. B. T.-A. M. Davim (Eds.), *Woodhead Publishing Reviews: Mechanical Engineering Series* (pp. 37–62). Woodhead Publishing. <https://doi.org/https://doi.org/10.1016/B978-0-12-822056-6.00002-3>
- Kulkarni, A., Dwivedi, D. K., & Vasudevan, M. (2020). Microstructure and mechanical properties of A-TIG welded AISI 316L SS-Alloy 800 dissimilar metal joint. *Materials Science & Engineering A*, 139685. <https://doi.org/10.1016/j.msea.2020.139685>
- Lakshminarayanan, A. K., Balasubramanian, V., & Elangovan, K. (2009). Effect of welding processes on tensile properties of AA6061 aluminium alloy joints. *International Journal of Advanced Manufacturing Technology*, 40(3–4), 286–296. <https://doi.org/10.1007/s00170-007-1325-0>
- Le, V. T., Si, D., Khoa, T., & Paris, H. (2021). Wire and arc additive manufacturing of 308L stainless steel components : Optimization of processing parameters and material properties. *Engineering Science and Technology, an International Journal*, 24(4), 1015–1026. <https://doi.org/10.1016/j.jestch.2021.01.009>
- Lee, J. H., Lee, C. M., & Kim, D. H. (2022). Repair of damaged parts using wire arc additive manufacturing in machine tools. *Journal of Materials Research and Technology*, 16, 13–24. <https://doi.org/10.1016/j.jmrt.2021.11.156>
- Leino, M., Pekkarinen, J., & Soukka, R. (2016). The role of laser additive manufacturing methods of metals in repair, refurbishment and remanufacturing - Enabling circular economy. *Physics Procedia*, 83, 752–760. <https://doi.org/10.1016/j.phpro.2016.08.077>
- Lewis, S. R., Lewis, R., & Fletcher, D. I. (2015). Assessment of laser cladding as an option for repairing/enhancing rails. *Wear*, 330–331, 581–591. <https://doi.org/10.1016/j.wear.2015.02.027>
- Li, F., Chen, S., Shi, J., Tian, H., & Zhao, Y. (2017). Evaluation and Optimization of a Hybrid Manufacturing Process Combining Wire Arc Additive Manufacturing with Milling for the Fabrication of Stiffened Panels. *Applied Sciences*, 7(12), 1233. <https://doi.org/10.3390/app7121233>
- Li, Y., Dong, S., Yan, S., Liu, X., He, P., & Xu, B. (2018). Surface remanufacturing of ductile cast iron by laser cladding Ni-Cu alloy coatings. *Surface and Coatings Technology*, 347(March), 20–28. <https://doi.org/10.1016/j.surfcoat.2018.04.065>
- Li, Y., Han, Q., Horváth, I., & Zhang, G. (2019a). Repairing surface defects of metal parts by groove machining and wire + arc based filling. *Journal of Materials Processing Technology*, 274, 116268. <https://doi.org/10.1016/J.JMATPROTEC.2019.116268>
- Li, Y., Han, Q., Horváth, I., & Zhang, G. (2019b). Repairing surface defects of metal parts by groove machining and wire + arc based filling. *Journal of Materials Processing Technology*, 274(92), 116268. <https://doi.org/10.1016/j.jmatprotec.2019.116268>
- Li, Y., Su, C., & Zhu, J. (2022). Comprehensive review of wire arc additive manufacturing: Hardware system, physical process, monitoring, property characterization, application and future prospects. *Results in Engineering*, 13(December 2021), 100330. <https://doi.org/10.1016/j.rineng.2021.100330>
- Lin, Z., Song, K., & Yu, X. (2021). A review on wire and arc additive manufacturing of titanium alloy. *Journal of Manufacturing Processes*, 70(May), 24–45. <https://doi.org/10.1016/j.jmapro.2021.08.018>
- Lipskas, J., Deep, K., & Yao, W. (2019). Robotic-Assisted 3D Bio-printing for Repairing Bone and Cartilage Defects through a Minimally Invasive Approach. *Scientific Reports*, 9(1), 0–31. <https://doi.org/10.1038/s41598-019-38972-2>
- Liu, D., Lippold, J. C., Li, J., Rohklin, S. R., Vollbrecht, J., & Grylls, R. (2014). Laser engineered net shape (LENS) technology for the repair of Ni-base superalloy turbine components. *Metallurgical and Materials Transactions A: Physical Metallurgy and Materials Science*, 45(10), 4454–4469. <https://doi.org/10.1007/s11661-014-2397-8>
- Liu, L., Zhuang, Z., Liu, F., & Zhu, M. (2013). Additive manufacturing of steel-bronze bimetal by shaped metal deposition: Interface characteristics and tensile properties. *International Journal of Advanced Manufacturing Technology*, 69(9–12),



- 2131–2137. <https://doi.org/10.1007/s00170-013-5191-7>
- Liu, Y., Wang, W., Xie, J., Sun, S., Wang, L., Qian, Y., Meng, Y., & Wei, Y. (2012). Microstructure and mechanical properties of aluminum 5083 weldments by gas tungsten arc and gas metal arc welding. *Materials Science and Engineering A*, 549, 7–13. <https://doi.org/10.1016/j.msea.2012.03.108>
- Lorenz, K. A., Jones, J. B., Wimpenny, D. I., & Jackson, M. R. (2020). A review of hybrid manufacturing. *Proceedings - 26th Annual International Solid Freeform Fabrication Symposium - An Additive Manufacturing Conference, SFF 2015*, 96–108.
- Lu, G., & Zangari, G. (2002). Corrosion resistance of ternary Ni-P based alloys in sulfuric acid solutions. *Electrochimica Acta*, 47(18), 2969–2979. [https://doi.org/10.1016/S0013-4686\(02\)00198-6](https://doi.org/10.1016/S0013-4686(02)00198-6)
- Maranhão, C., & Davim, J. P. (2012). Residual stresses in machining using FEM analysis - A review. *Reviews on Advanced Materials Science*, 30(3), 267–272.
- Marenych, O. O., Kostryzhev, A. G., Pan, Z., Li, H., & van Duin, S. (2021). Application of wire arc additive manufacturing for repair of Monel alloy components. *Australian Journal of Mechanical Engineering*, 19(5), 609–617. <https://doi.org/10.1080/14484846.2021.1981528>
- Marinelli, G., Martina, F., Ganguly, S., Williams, S., Lewtas, H., Hancock, D., Mehraban, S., & Lavery, N. (2019). Microstructure and thermal properties of unalloyed tungsten deposited by Wire + Arc Additive Manufacture. *Journal of Nuclear Materials*, 522, 45–53. <https://doi.org/10.1016/J.JNUCMAT.2019.04.049>
- Martina, F., Colegrove, P. A., Williams, S. W., & Meyer, J. (2015). Microstructure of Interpass Rolled Wire + Arc Additive Manufacturing Ti-6Al-4V Components. *Metallurgical and Materials Transactions A: Physical Metallurgy and Materials Science*, 46(12), 6103–6118. <https://doi.org/10.1007/s11661-015-3172-1>
- Martina, F., Roy, M., Colegrove, P., & Williams, S. W. (2014). Residual stress reduction in high pressure interpass rolled wire+arc additive manufacturing Ti-6Al-4V components. *25th Annual International Solid Freeform Fabrication Symposium & #65533; An Additive Manufacturing Conference, SFF 2014*, 89–94.
- Meiners, F., Ihne, J., Jürgens, P., Hemes, S., Mathes, M., Sizova, I., Bambach, M., Hama-Saleh, R., & Weisheit, A. (2020). New hybrid manufacturing routes combining forging and additive manufacturing to efficiently produce high performance components from Ti-6Al-4V. *Procedia Manufacturing*, 47(2019), 261–267. <https://doi.org/10.1016/j.promfg.2020.04.215>
- Mhapsekar, K., McConaha, M., & Anand, S. (2018). Additive Manufacturing Constraints in Topology Optimization for Improved Manufacturability. *Journal of Manufacturing Science and Engineering*, 140(5). <https://doi.org/10.1115/1.4039198>
- Michel, F., Lockett, H., Ding, J., Martina, F., Marinelli, G., & Williams, S. (2019). A modular path planning solution for Wire + Arc Additive Manufacturing. *Robotics and Computer-Integrated Manufacturing*, 60(April), 1–11. <https://doi.org/10.1016/j.rcim.2019.05.009>
- Montgomery, D. C. A. S. U. (2017). Design and Analysis of Experiments Ninth Edition. In *Arizona State University*.
- Motallebi, R., Savaedi, Z., & Mirzadeh, H. (2022). Additive manufacturing – A review of hot deformation behavior and constitutive modeling of flow stress. *Current Opinion in Solid State and Materials Science*, 26(3), 100992. <https://doi.org/10.1016/j.cossms.2022.100992>
- Mudge, R. P., & Wald, N. R. (2007). Laser engineered net shaping advances additive manufacturing and repair. *Welding Journal (Miami, Fla)*, 86(1), 44–48.
- Murr, L. E., Gaytan, S. M., Ceylan, A., Martinez, E., & Martinez, J. L. (2010). Characterization of titanium aluminide alloy components fabricated by additive manufacturing using electron beam melting. *Acta Materialia*, 58(5), 1887–1894. <https://doi.org/10.1016/j.actamat.2009.11.032>
- Najmon, J. C., Raeisi, S., & Tovar, A. (2019). Review of additive manufacturing technologies and applications in the aerospace industry. *Additive Manufacturing for the Aerospace Industry*, 7–31. <https://doi.org/10.1016/B978-0-12-814062-8.00002-9>
- Negi, S., Kapil, S., Sharma, A., Choudhary, P., Bhargava, P., & Karunakaran, K. P. (2020). Retrofitment of Laser Cladding System with CNC Machine for Hybrid Layer Manufacturing. In M. S. Shunmugam & M. Kanthababu (Eds.), *Advances in Additive Manufacturing and Joining* (pp. 47–59). Springer Singapore.
- Negi, S., Nambolan, A. A., Kapil, S., Joshi, P. S., R. M., Karunakaran, K. P., & Bhargava, P. (2020). Review on electron beam based additive manufacturing. *Rapid Prototyping Journal*, 26(3), 485–498. <https://doi.org/10.1108/RPJ-07-2019-0182>
- Nowotny, S., Scharek, S., Beyer, E., & Richter, K. H. (2007). Laser beam build-up welding: Precision in repair, surface cladding, and direct 3D metal deposition. *Journal of Thermal Spray Technology*, 16(3), 344–348. <https://doi.org/10.1007/s11666-007-9028-5>
- Oh, W. J., Lee, W. J., Kim, M. S., Jeon, J. B., & Shim, D. S. (2019). Repairing additive-manufactured 316L stainless steel using direct energy deposition. *Optics and Laser Technology*, 117, 6–17. <https://doi.org/10.1016/j.optlastec.2019.04.012>
- Onuikwe, B., & Bandyopadhyay, A. (2019). Additive manufacturing in repair: Influence of processing parameters on properties of Inconel 718. *Materials Letters*, 252, 256–259. <https://doi.org/10.1016/j.matlet.2019.05.114>
- Pant, P. (2020). *Residual stress distributions in additively manufactured parts: effect of build orientation* (Vol. 1869). Linköping University Electronic Press.
- Patel, M., Mulgaonkar, S., Desai, H., & Borse, T. (2021). Development and Implementation of Wire Arc Additive Manufacturing (WAAM) Based on Pulse Spray GMAW for Aluminum Alloy (AlSi7Mg). *Transactions of the Indian Institute of Metals*, 74(5), 1129–1140. <https://doi.org/10.1007/s12666-020-02154-w>

- Peng, X., Kong, L., Fuh, J. Y. H., & Wang, H. (2021). A review of post-processing technologies in additive manufacturing. In *Journal of Manufacturing and Materials Processing* (Vol. 5, Issue 2). <https://doi.org/10.3390/jmmp5020038>
- Pinkerton, A. J. (2010). Laser direct metal deposition: Theory and applications in manufacturing and maintenance. *Advances in Laser Materials Processing: Technology, Research and Application*, 461–491. <https://doi.org/10.1533/9781845699819.6.461>
- Piscopo, G., & Iuliano, L. (2022). Current research and industrial application of laser powder directed energy deposition. *International Journal of Advanced Manufacturing Technology*, 119(11–12), 6893–6917. <https://doi.org/10.1007/s00170-021-08596-w>
- Poonnayom, P., & Kimapong, K. (2018). SMAW electrodes selection for producing hard-faced layer on FC25 cast iron surface. *Key Engineering Materials*, 777 KEM, 339–343. <https://doi.org/10.4028/www.scientific.net/KEM.777.339>
- Prado-Cerqueira, J. L., Diéguez, J. L., & Camacho, A. M. (2017). Preliminary development of a Wire and Arc Additive Manufacturing system (WAAM). *Procedia Manufacturing*, 13, 895–902. <https://doi.org/10.1016/j.promfg.2017.09.154>
- Radaj, D. (1990). Fracture mechanics approach for assessment of fatigue strength of seam welded joints. *Design and Analysis of Fatigue Resistant Welded Structures*, 277–298. <https://doi.org/10.1533/9781845698751.277>
- Rahito, Wahab, D. A., & Azman, A. H. (2019). Additive manufacturing for repair and restoration in remanufacturing: An overview from object design and systems perspectives. In *Processes* (Vol. 7, Issue 11). <https://doi.org/10.3390/pr7110802>
- Raut, L. P., & Taiwade, R. V. (2021). Wire Arc Additive Manufacturing: A Comprehensive Review and Research Directions. *Journal of Materials Engineering and Performance*, 30(7), 4768–4791. <https://doi.org/10.1007/s11665-021-05871-5>
- Ravi, G., Murugan, N., & Arulmani, R. (2020). Microstructure and mechanical properties of Inconel-625 slab component fabricated by wire arc additive manufacturing. *Materials Science and Technology (United Kingdom)*, 36(16), 1785–1795. <https://doi.org/10.1080/02670836.2020.1836737>
- Reisch, R., Hauser, T., Kamps, T., & Knoll, A. (2020). Robot based wire arc additive manufacturing system with context-sensitive multivariate monitoring framework. *Procedia Manufacturing*, 51(2019), 732–739. <https://doi.org/10.1016/j.promfg.2020.10.103>
- Reisgen, U., Sharma, R., Mann, S., & Oster, L. (2020). Increasing the manufacturing efficiency of WAAM by advanced cooling strategies. *Welding in the World*, 64(8), 1409–1416. <https://doi.org/10.1007/s40194-020-00930-2>
- Ren, L., Gu, H., Wang, W., Wang, S., Li, C., Wang, Z., Zhai, Y., & Ma, P. (2020). The Microstructure and Properties of an Al-Mg-0.3Sc Alloy Deposited by Wire Arc Additive Manufacturing. *Metals*, 10(320).
- Ren, L., Padathu, A. P., Ruan, J., Sparks, T., & Liou, F. W. (2006). Three dimensional die repair using a hybrid manufacturing system. *17th Solid Freeform Fabrication Symposium, SFF 2006*, 51–59.
- Ríos, S., Colegrove, P. A., & Williams, S. W. (2019). Metal transfer modes in plasma Wire + Arc additive manufacture. *Journal of Materials Processing Technology*, 264, 45–54. <https://doi.org/10.1016/J.JMATPROTEC.2018.08.043>
- Rodrigues, T. A., Bairrão, N., Farias, F. W. C., Shamsolhodaei, A., Shen, J., Zhou, N., Maawad, E., Schell, N., Santos, T. G., & Oliveira, J. P. (2022). Steel-copper functionally graded material produced by twin-wire and arc additive manufacturing (T-WAAM). *Materials and Design*, 213, 110270. <https://doi.org/10.1016/j.matdes.2021.110270>
- Rodrigues, T. A., Duarte, V., Miranda, R. M., Santos, T. G., & Oliveira, J. P. (2019). Current status and perspectives on wire and arc additive manufacturing (WAAM). *Materials*, 12(7). <https://doi.org/10.3390/ma12071121>
- Rodrigues, T. A., Duarte, V. R., Miranda, R. M., Santos, T. G., & Oliveira, J. P. (2021). Ultracold-Wire and arc additive manufacturing (UC-WAAM). *Journal of Materials Processing Technology*, 296(April), 117196. <https://doi.org/10.1016/j.jmatprotec.2021.117196>
- Rodriguez, N., Vázquez, L., Huarte, I., Arruti, E., Tabernero, I., & Alvarez, P. (2018). Wire and arc additive manufacturing: a comparison between CMT and TopTIG processes applied to stainless steel. *Welding in the World*, 62(5), 1083–1096. <https://doi.org/10.1007/s40194-018-0606-6>
- Rosli, N. A., Alkahari, M. R., bin Abdollah, M. F., Maidin, S., Ramli, F. R., & Herawan, S. G. (2021). Review on effect of heat input for wire arc additive manufacturing process. *Journal of Materials Research and Technology*, 11, 2127–2145. <https://doi.org/10.1016/J.JMRT.2021.02.002>
- Rossini, N. S., Dassisti, M., Benyounis, K. Y., & Olabi, A. G. (2012). Methods of measuring residual stresses in components. *Materials and Design*, 35, 572–588. <https://doi.org/10.1016/j.matdes.2011.08.022>
- Rumman, R., Lewis, D. A., Hascoet, J. Y., & Quinton, J. S. (2019). Laser metal deposition and wire arc additive manufacturing of materials: An overview. *Archives of Metallurgy and Materials*, 64(2), 467–473. <https://doi.org/10.24425/amm.2019.127561>
- Ryan, E. M. (2018). *On Wire and Arc Additive Manufacture of Aluminium* (Issue September).
- Saboori, A., Aversa, A., Marchese, G., Biamino, S., Lombardi, M., & Fino, P. (2019). Application of directed energy deposition-based additive manufacturing in repair. *Applied Sciences (Switzerland)*, 9(16). <https://doi.org/10.3390/app9163316>
- Salmi, M. (2021). Additive Manufacturing Processes in Medical Applications. *Materials*, 14(1), 191. <https://doi.org/10.3390/ma14010191>
- Sames, W. J., List, F. A., Pannala, S., Dehoff, R. R., & Babu, S. S. (2016). The metallurgy and processing science of metal additive manufacturing. *International Materials Reviews*, 61(5), 315–360. <https://doi.org/10.1080/09506608.2015.1116649>
- Sarathchandra, D. T., Davidson, M. J., & Visvanathan, G. (2020). Parameters effect on SS304 beads deposited by wire arc additive manufacturing. *Materials and Manufacturing Processes*, 35(7), 852–858.

- <https://doi.org/10.1080/10426914.2020.1743852>
- Schroepfer, D., Kromm, A., & Kannengiesser, T. (2017). Engineering approach to assess residual stresses in welded components. *Welding in the World*, 61(1), 91–106. <https://doi.org/10.1007/s40194-016-0394-9>
- Selvi, S., Vishvaksean, A., & Rajasekar, E. (2017). SC. *Defence Technology*. <https://doi.org/10.1016/j.dt.2017.08.002>
- Senthil, T. S., Ramesh Babu, S., Puviyarasan, M., & Dhinakaran, V. (2021). Mechanical and microstructural characterization of functionally graded Inconel 825 - SS316L fabricated using wire arc additive manufacturing. *Journal of Materials Research and Technology*, 15, 661–669. <https://doi.org/10.1016/j.jmrt.2021.08.060>
- Seow, C. E., Coules, H. E., Wu, G., Khan, R. H. U., Xu, X., & Williams, S. (2019). Wire + Arc Additively Manufactured Inconel 718: Effect of post-deposition heat treatments on microstructure and tensile properties. *Materials and Design*, 183, 108157. <https://doi.org/10.1016/j.matdes.2019.108157>
- Shah, A., Aliyev, R., Zeidler, H., & Krinke, S. (2023). A Review of the Recent Developments and Challenges in Wire Arc Additive Manufacturing (WAAM) Process. *Journal of Manufacturing and Materials Processing*, 7(3), 1–30. <https://doi.org/10.3390/jmmp7030097>
- Shim, D. S., Lee, H., Son, Y., & Oh, W. J. (2021). Effects of pre- and post-repair heat treatments on microstructure and tensile behaviors of 630 stainless steel repaired by metal additive manufacturing. *Journal of Materials Research and Technology*, 13, 980–999. <https://doi.org/10.1016/j.jmrt.2021.05.039>
- Shojaati, M., Farshid, S., Bozorg, K., Vatanara, M., Yazdizadeh, M., Abbasi, M., & Ph, D. (2020). International Journal of Pressure Vessels and Piping The heat affected zone of X20Cr13 martensitic stainless steel after multiple repair welding : Microstructure and mechanical properties assessment. *International Journal of Pressure Vessels and Piping*, 188(September), 104205. <https://doi.org/10.1016/j.ijpvp.2020.104205>
- Singh, A., Kapil, S., & Das, M. (2020). A comprehensive review of the methods and mechanisms for powder feedstock handling in directed energy deposition. *Additive Manufacturing*, 35, 101388. <https://doi.org/10.1016/J.ADDMA.2020.101388>
- Singh, S. R., & Khanna, P. (2021). Wire arc additive manufacturing (WAAM): A new process to shape engineering materials. *Materials Today: Proceedings*, 44(xxxx), 118–128. <https://doi.org/10.1016/j.matpr.2020.08.030>
- Somlo, K., & Sziebig, G. (2019). Aspects of multi-pass GTAW of low alloyed steels. *IFAC-PapersOnLine*, 52(22), 101–107. <https://doi.org/10.1016/j.ifacol.2019.11.056>
- Squires, L., Roberts, E., & Bandyopadhyay, A. (2023). Radial bimetallic structures via wire arc directed energy deposition-based additive manufacturing. *Nature Communications*, 14(1). <https://doi.org/10.1038/s41467-023-39230-w>
- Srivastava, M., & Rathee, S. (2022). Additive manufacturing: recent trends, applications and future outlooks. *Progress in Additive Manufacturing*, 7(2), 261–287. <https://doi.org/10.1007/s40964-021-00229-8>
- Srivastava, S., & Garg, R. K. (2017). Process parameter optimization of gas metal arc welding on IS:2062 mild steel using response surface methodology. *Journal of Manufacturing Processes*, 25, 296–305. <https://doi.org/10.1016/j.jmapro.2016.12.016>
- Srivastava, S., Garg, R. K., Sharma, V. S., & Sachdeva, A. (2021). Measurement and Mitigation of Residual Stress in Wire-Arc Additive Manufacturing: A Review of Macro-Scale Continuum Modelling Approach. *Archives of Computational Methods in Engineering*, 28(5), 3491–3515. <https://doi.org/10.1007/s11831-020-09511-4>
- Sun, S. Da, Liu, Q., Brandt, M., Luzin, V., Cottam, R., Janardhana, M., & Clark, G. (2014). Effect of laser clad repair on the fatigue behaviour of ultra-high strength AISI 4340 steel. *Materials Science and Engineering A*, 606, 46–57. <https://doi.org/10.1016/j.msea.2014.03.077>
- Svetlizky, D., Das, M., Zheng, B., Vyatskikh, A. L., Bose, S., Bandyopadhyay, A., Schoenung, J. M., Lavernia, E. J., & Eliaz, N. (2021). Directed energy deposition (DED) additive manufacturing: Physical characteristics, defects, challenges and applications. *Materials Today*, 49, 271–295. <https://doi.org/10.1016/J.MATTOD.2021.03.020>
- Szost, B. A., Terzi, S., Martina, F., Boisselier, D., Prytuliak, A., Pirling, T., Hofmann, M., & Jarvis, D. J. (2016). A comparative study of additive manufacturing techniques: Residual stress and microstructural analysis of CLAD and WAAM printed Ti-6Al-4V components. *Materials and Design*, 89, 559–567. <https://doi.org/10.1016/j.matdes.2015.09.115>
- Taek, A., Kim, B., Yue, S., Zhang, Z., Jones, J. R., & Lee, P. D. (2014). Ac ce p t. *Journal of Materials Processing Tech*. <https://doi.org/10.1016/j.jmatprotec.2014.05.006>
- Tanvir, A. N. M., Ahsan, M. R. U., Seo, G., Kim, J. duk, Ji, C., Bates, B., Lee, Y., & Kim, D. B. (2020). Heat treatment effects on Inconel 625 components fabricated by wire + arc additively manufacturing (WAAM)—part 2: mechanical properties. *International Journal of Advanced Manufacturing Technology*, 110(7–8), 1709–1721. <https://doi.org/10.1007/s00170-020-05980-w>
- Tarng, Y. S., Juang, S. C., & Chang, C. H. (2002). The use of grey-based Taguchi methods to determine submerged arc welding process parameters in hardfacing. *Journal of Materials Processing Technology*, 128(1–3), 1–6. [https://doi.org/10.1016/S0924-0136\(01\)01261-4](https://doi.org/10.1016/S0924-0136(01)01261-4)
- Taşdemir, A., & Nohut, S. (2020). An overview of wire arc additive manufacturing (WAAM) in shipbuilding industry. *Ships and Offshore Structures*, 0(0), 1–18. <https://doi.org/10.1080/17445302.2020.1786232>
- Thapliyal, S. (2019). Challenges associated with the wire arc additive manufacturing (WAAM) of aluminum alloys. In *Materials Research Express* (Vol. 6, Issue 11, p. 112006). <https://doi.org/10.1088/2053-1591/ab4dd4>
- Tomar, B., Shiva, S., & Nath, T. (2022). A review on wire arc additive manufacturing: Processing parameters, defects, quality improvement and recent advances. *Materials Today Communications*, 31, 103739.

- <https://doi.org/10.1016/J.MTCOMM.2022.103739>
- Ünsal, I., Hirtler, M., Sviridov, A., & Bambach, M. (2020). Material properties of features produced from EN AW 6016 by wire-arc additive manufacturing. *Procedia Manufacturing*, 47(2019), 1129–1133. <https://doi.org/10.1016/j.promfg.2020.04.131>
- Uriondo, A., Esperon-Miguez, M., & Perinpanayagam, S. (2015). The present and future of additive manufacturing in the aerospace sector: A review of important aspects. *Proceedings of the Institution of Mechanical Engineers, Part G: Journal of Aerospace Engineering*, 229(11), 2132–2147. <https://doi.org/10.1177/0954410014568797>
- Varghese, O. K. (2003). *Crystallization and high-temperature structural stability of titanium oxide nanotube arrays*.
- Veiga, F., Del Val, A. G., Suárez, A., & Alonso, U. (2020). Analysis of the machining process of titanium Ti6Al-4V parts manufactured by wire arc additive manufacturing (WAAM). *Materials*, 13(3). <https://doi.org/10.3390/ma13030766>
- Veiga, F., Suárez, A., Aldalur, E., Goenaga, I., & Amondarain, J. (2023). Wire Arc Additive Manufacturing Process for Topologically Optimized Aeronautical Fixtures. *3D Printing and Additive Manufacturing*, 10(1), 23–33. <https://doi.org/10.1089/3dp.2021.0008>
- Vishnukumar, M., Pramod, R., & Rajesh Kannan, A. (2021). Wire arc additive manufacturing for repairing aluminium structures in marine applications. *Materials Letters*, 299, 130112. <https://doi.org/10.1016/j.matlet.2021.130112>
- Wandtke, K., Schroeffer, D., Scharf-Wildenhain, R., Haelsig, A., Kannengiesser, T., Kromm, A., & Hensel, J. (2023). Influence of the WAAM process and design aspects on residual stresses in high-strength structural steels. *Welding in the World*, 0123456789, 1–10. <https://doi.org/10.1007/s40194-023-01503-9>
- Wang, J. F., Sun, Q. J., Wang, H., Liu, J. P., & Feng, J. C. (2016). Effect of location on microstructure and mechanical properties of additive layer manufactured Inconel 625 using gas tungsten arc welding. *Materials Science and Engineering A*, 676, 395–405. <https://doi.org/10.1016/j.msea.2016.09.015>
- Wang, J., Lin, X., Li, J., Xue, A., Liu, F., Huang, W., & Liang, E. (2020). A study on obtaining equiaxed prior- $\beta$  grains of wire and arc additive manufactured Ti-6Al-4V. *Materials Science and Engineering A*, 772, 138703. <https://doi.org/10.1016/j.msea.2019.138703>
- Wang, J., Zhu, K., Zhang, W., Zhu, X., & Lu, X. (2023). Microstructural and defect evolution during WAAM resulting in mechanical property differences for AA5356 component. *Journal of Materials Research and Technology*, 22, 982–996. <https://doi.org/10.1016/j.jmrt.2022.11.116>
- Wang, X., Wang, A., & Li, Y. (2020). Study on the deposition accuracy of omni-directional GTAW-based additive manufacturing. *Journal of Materials Processing Technology*, 282(February), 116649. <https://doi.org/10.1016/j.jmatprotec.2020.116649>
- Warsi, R., Kazmi, K. H., & Chandra, M. (2022). Mechanical properties of wire and arc additive manufactured component deposited by a CNC controlled GMAW. *Materials Today: Proceedings*, 56, 2818–2825. <https://doi.org/10.1016/J.MATPR.2021.10.114>
- Williams, S. W., Martina, F., Addison, A. C., Ding, J., Pardal, G., & Colegrove, P. (2016). Wire + Arc additive manufacturing. *Materials Science and Technology*, 32(7), 641–647. <https://doi.org/10.1179/1743284715Y.0000000073>
- Williams, S. W., Martina, F., Addison, A. C., Ding, J., Pardal, G., Colegrove, P., Number, D., Waammatt, S. W. W., Oct, A., Williams, S. W., Martina, F., & Williams, S. W. (2015). Wire+arc additive manufacturing vs. traditional machining from solid: a cost comparison. *Materials Science and Technology (United Kingdom)*, 32(October), 27.
- Wilson, J. M., Piya, C., Shin, Y. C., Zhao, F., & Ramani, K. (2014). Remanufacturing of turbine blades by laser direct deposition with its energy and environmental impact analysis. *Journal of Cleaner Production*, 80, 170–178. <https://doi.org/10.1016/j.jclepro.2014.05.084>
- Withers, P. J., & Bhadeshia, H. K. D. H. (2001). Residual stress part 2 - Nature and origins. *Materials Science and Technology*, 17(4), 366–375. <https://doi.org/10.1179/026708301101510087>
- Wu, B., Pan, Z., Ding, D., Cuiuri, D., Li, H., Xu, J., & Norrish, J. (2018). A review of the wire arc additive manufacturing of metals: properties, defects and quality improvement. *Journal of Manufacturing Processes*, 35, 127–139. <https://doi.org/10.1016/J.JMAPRO.2018.08.001>
- Wu, B., Qiu, Z., Pan, Z., Carpenter, K., Wang, T., Ding, D., Duin, S. Van, & Li, H. (2020). Enhanced interface strength in steel-nickel bimetallic component fabricated using wire arc additive manufacturing with interweaving deposition strategy. *Journal of Materials Science and Technology*, 52, 226–234. <https://doi.org/10.1016/j.jmst.2020.04.019>
- Xia, Y., Peng, M., Teng, H., Chen, Y., & Zhang, X. (2021). Multi-properties optimization of welding parameters of wire arc additive manufacture in dissimilar joint of iron-based alloy and nickel-based superalloy using grey-based Taguchi method. *Proceedings of the Institution of Mechanical Engineers, Part C: Journal of Mechanical Engineering Science*, 235(23), 6984–6995. <https://doi.org/10.1177/09544062211008928>
- Xin, H., Tarus, I., Cheng, L., Veljkovic, M., Persem, N., & Lorich, L. (2021). Experiments and numerical simulation of wire and arc additive manufactured steel materials. *Structures*, 34, 1393–1402. <https://doi.org/10.1016/J.ISTRUC.2021.08.055>
- Xiong, J., Liu, G., & Pi, Y. (2019). Increasing stability in robotic GTA-based additive manufacturing through optical measurement and feedback control. *Robotics and Computer-Integrated Manufacturing*, 59(May 2018), 385–393. <https://doi.org/10.1016/j.rcim.2019.05.012>
- Xu, F. J., Lv, Y. H., Xu, B. S., Liu, Y. X., Shu, F. Y., & He, P. (2013). Effect of deposition strategy on the microstructure and mechanical properties of Inconel 625 superalloy fabricated by pulsed plasma arc deposition. *Materials and Design*, 45, 446–455. <https://doi.org/10.1016/j.matdes.2012.07.013>
- Yan, L. (2013). Wire and Arc Additive Manufacture (WAAM) reusable tooling investigation. *SCHOOL OF APPLIED*

- SCIENCE MRes Welding Engineering, October*, 1–34.
- Yang, H., & Luo, D. (2019). *A Study of Additive Manufacturing Technology's Development and Impact - Through the Multi-Level Perspective Framework and the Case of Adidas*.
- Yehorov, Y., da Silva, L. J., & Scotti, A. (2019). Balancing WAAM production costs and wall surface quality through parameter selection: A case study of an Al-Mg5 alloy multilayer-non-oscillated single pass wall. *Journal of Manufacturing and Materials Processing*, 3(2). <https://doi.org/10.3390/jmmp3020032>
- Yilmaz, O., Gindy, N., & Gao, J. (2010). A repair and overhaul methodology for aeroengine components. *Robotics and Computer-Integrated Manufacturing*, 26(2), 190–201. <https://doi.org/10.1016/j.rcim.2009.07.001>
- Yoo, S. W., Lee, C. M., & Kim, D. H. (2023). Effect of Functionally Graded Material (FGM) Interlayer in Metal Additive Manufacturing of Inconel-Stainless Bimetallic Structure by Laser Melting Deposition (LMD) and Wire Arc Additive Manufacturing (WAAM). *Materials*, 16(2). <https://doi.org/10.3390/ma16020535>
- Yuan, L., Ding, D., Pan, Z., Yu, Z., Wu, B., Van Duin, S., Li, H., & Li, W. (2020). Application of multidirectional robotic wire arc additive manufacturing process for the fabrication of complex metallic parts. *IEEE Transactions on Industrial Informatics*, 16(1), 454–464. <https://doi.org/10.1109/TII.2019.2935233>
- Yuan, L., Pan, Z., Ding, D., He, F., van Duin, S., Li, H., & Li, W. (2020). Investigation of humping phenomenon for the multi-directional robotic wire arc additive manufacturing. *Robotics and Computer-Integrated Manufacturing*, 63(July 2019), 101916. <https://doi.org/10.1016/j.rcim.2019.101916>
- Yusuf, S. M., Cutler, S., & Gao, N. (2019). Review : The Impact of Metal Additive. *Metals*, 9, 1286.
- Zeng, Z., Cong, B. Q., Oliveira, J. P., Ke, W. C., Schell, N., Peng, B., Qi, Z. W., Ge, F. G., Zhang, W., & Ao, S. S. (2020). Wire and arc additive manufacturing of a Ni-rich NiTi shape memory alloy: Microstructure and mechanical properties. *Additive Manufacturing*, 32, 101051. <https://doi.org/10.1016/j.addma.2020.101051>
- Zhai, Y., & Ma, P. (2016). Materials Science & Engineering A The strengthening effect of inter-layer cold working and post-deposition heat treatment on the additively manufactured Al – 6 . 3Cu alloy. *Materials Science & Engineering A*, 651, 18–26. <https://doi.org/10.1016/j.msea.2015.10.101>
- Zhang, W., Ding, C., Wang, H., Meng, W., Xu, Z., & Wang, J. (2021). The Forming Profile Model for Cold Metal Transfer and Plasma Wire-Arc Deposition of Nickel-Based Alloy. *Journal of Materials Engineering and Performance*, 30(7), 4872–4881. <https://doi.org/10.1007/s11665-021-05485-x>
- Zhang, X., Cui, W., Li, W., & Liou, F. (2019). A hybrid process integrating reverse engineering, pre-repair processing, additive manufacturing, and material testing for component remanufacturing. *Materials*, 12(12). <https://doi.org/10.3390/ma12121961>
- Zhang, X., & Liou, F. (2021). Introduction to additive manufacturing. *Additive Manufacturing*, 1–31. <https://doi.org/10.1016/B978-0-12-818411-0.00009-4>
- Zhang, X., Wang, K., Zhou, Q., Ding, J., Ganguly, S., Grasso, M., Yang, D., Xu, X., Dirisu, P., & Williams, S. W. (2019). Microstructure and mechanical properties of TOP-TIG-wire and arc additive manufactured super duplex stainless steel (ER2594). *Materials Science and Engineering A*, 762(August 2018), 138097. <https://doi.org/10.1016/j.msea.2019.138097>
- Zhou, Y., Lin, X., Kang, N., Huang, W., & Wang, Z. (2021). Mechanical properties and precipitation behavior of the heat-treated wire + arc additively manufactured 2219 aluminum alloy. *Materials Characterization*, 171, 110735. <https://doi.org/10.1016/j.matchar.2020.110735>
- Zhuo, Y., Yang, C., Fan, C., Lin, S., Chen, C., & Cai, X. (2020). Microstructure and mechanical properties of wire arc additive repairing Ti–6.5Al–2Sn–2Zr–4Mo–4Cr titanium alloy. *Materials Science and Technology (United Kingdom)*, 36(15), 1712–1719. <https://doi.org/10.1080/02670836.2020.1822061>
- Ziółkowski, M., & Dyl, T. (2020). Possible applications of additive manufacturing technologies in shipbuilding: A review. *Machines*, 8(4), 1–34. <https://doi.org/10.3390/machines8040084>





© 2024 by the authors; licensee Growing Science, Canada. This is an open access article distributed under the terms and conditions of the Creative Commons Attribution (CC-BY) license (<http://creativecommons.org/licenses/by/4.0/>).