

Negative stiffness honeycomb structure as automobile leaf spring: A numerical investigation**Fahim Faisal Arnob^a, Md Sayed Anwar^b, Md Shariful Islam^{a*}, Md Arifuzzaman^a and Md Abdullah Al Bari^c**^a*Department of Mechanical Engineering, Khulna University of Engineering & Technology, Khulna, Bangladesh*^b*Department of Mechanical Engineering, Sonargaon University, Dhaka, Bangladesh*^c*Department of Chemical and Petroleum Engineering, University of Calgary, Alberta, Canada***ARTICLE INFO***Article history:*

Received 10 April 2023

Accepted 16 May 2023

Available online

16 May 2023

*Keywords:**Leaf spring**Negative stiffness honeycomb structure**Modal analysis**Fatigue life***ABSTRACT**

The leaf spring is one of the main components in an automobile which carries the weight of the vehicle and passenger as well as absorbs the vibration and shock produced due to road irregularities. The weight, natural frequency, stress developed, energy absorption, fatigue life, etc. are the key factors that need to be considered to design a leaf spring. Towards that, a novel design integrating a Negative Stiffness Honeycomb Structure (NSHS) in the leaf spring is proposed. The proposed design and the traditional leaf spring are analyzed using the commercially available Finite Element Method (FEM) software Abaqus. Both the traditional and NSHS models were created using Solidworks and modal, harmonic, structural, and transient analyses were performed. It is found that the natural frequency of the NSHS leaf spring is well above the frequency produced due to road irregularities although it is lower than the traditional spring. The total weight of the NSHS spring structure is reduced significantly by 30.73% compared to the traditional spring. Structural analysis shows a lower stress development and higher energy absorption capacity for the NSHS leaf spring. Transient analysis reveals lower mean stress in the proposed NSHS spring. The fatigue life is also found to be 82.78% higher in the proposed design. The NSHS-incorporated novel leaf spring design may be an excellent alternative to the traditional leaf spring.

© 2023 Growing Science Ltd. All rights reserved.

1. Introduction

Leaf spring is one of the main components used in automobiles (Shamim & Anwer, 2014) and its purpose is to carry the load and absorb energy when a vehicle moves over a bump or rough road (Ismaeel, 2015). A leaf spring is a structure that is often subjected to large deflection. It deflects under compressive or shear load during vehicle movement and returns to its original position when the load is removed. It reduces the vibration caused by road irregularities and also absorbs the energy for a smoother ride for the passengers (D'Silva & Jain, 2014). Normally, several parabolic leaves are placed on top of each other and tied together by means of a nut and bolt to form a single leaf spring. Leaf spring has the advantage of carrying large loads compared to coil springs however it has a major drawback that it produces large stress on leaves which restricts the use of costly high-strength materials (Rajesh & Sreekumar, 2016). Leaf spring is one of the oldest parts of an automobile and numerous researchers studied the characteristics of leaf springs over the years. Most of the research was based on the materials of the leaf spring. Krishan and Aggarwal (2012) used the finite element analysis (FEA) approach to simulate the stress distribution and deflection of a multi-leaf spring of conventional design and compared it to experimental data. DIN 65Si7 leaf spring material was used in their analysis and found that the stress concentration occurs on the eyes of the leaf. Shamim and Answer (2014) used the finite element method (FEM) to compare three multi-leaf springs made of AISI 6150 steel, Ti-6Al-4V alloy, and S-glass fiber composite to find the material for which the least vertical vibration and stress occurs. The harmonic

* Corresponding author. Tel.: +880-1779-876378

E-mail addresses: msislam@me.kuet.ac.bd (Md S. Islam)

analysis of these leaf springs revealed that at lower frequencies, AISI 6150 steel showed the least displacement while at higher frequencies, the S-glass fiber composite leaf spring performed better. The use of composites also resulted in mass reduction. Titanium alloy outperformed the other two materials in terms of induced stress. Cho et al. (2017) used Chromium steel AISI 5150 and optimized the thickness and width of the leaf spring in terms of von Mises stress and working frequency. The development of composite materials leads to the potential use of these materials in automobile leaf springs. Mehul et al. (2012) compared a standard SUP 9 leaf spring to a composite leaf spring consisting of carbon/epoxy and graphite/epoxy unidirectional laminates. They found a 79.62 % reduction of weight in the case of multi-leaf spring and 90.09 % in the case of an identical mono-leaf spring for the same loading condition when standard spring material was replaced with composite spring material. Baviskar et al. (2013) presented a review on the design and analysis of leaf spring performance and failure in leaf springs. They found that while the use of composite materials for the construction of leaf springs may produce better outcomes than standard steel, it is not necessarily a cost-effective as its competitors. The stress comparison between composite and standard steel leaf springs reveals that the composite leaf experiences significantly less induced stress during operation. E-glass/epoxy composite yielded better results in terms of stress compared to regular spring steel. Shiva Shankar and Vijayarangan (2006) manufactured glass fiber reinforced polymer composite (GFRP) leaf springs and found that the stress developed in GFRP composite was lower than that of spring steel. They have also reported an 85 % decrease in weight due to the replacement of spring steel by GFRP. Rao and Venkatesh (2015) numerically investigated four different composites along with steel. They found that Kevlar/epoxy composites have higher natural frequency compared to E-glass/epoxy, Graphite/epoxy, Carbon/epoxy, and steel while the weight was reduced for Kevlar/epoxy composite by 82.82 %. Noronha et al. (2020) also numerically studied several composite materials along with conventional spring and found that Kevlar/epoxy is better in terms of deformation, energy absorption, natural frequency, fatigue life, etc. Zhang et al. (2022) have investigated the effect of fiber orientation on the stiffness and damping properties of glass fiber composite.

Most of the researchers focused their work on the replacement of traditional leaf spring materials with composite materials. However, very few studies were found based on the structure of the leaf spring. Rajesh and Sreekumar (2016) proposed two novel designs of leaf spring structures where they used solid and hollow cylinders between two master leaves and found that their designed leaf springs outperformed in terms of natural frequency, von Mises stress, etc. Soner et al. (2011) suggested a design adjustment to a standard multilayer parabolic leaf spring to minimize weight while maintaining durability. Instead of 5 layers of the leaf, they employed 4 layers with increasing thickness of the master leaf, resulting in a homogenous stress distribution throughout the entire leaf as opposed to specific local stress concentration on the 5 layers design.

Most of the structure absorbs energy through plastic deformation and cannot be recovered to its original shape. However, the Negative Stiffness Structure (NSS) can absorb energy without any plastic deformation and the energy can be recovered nearly perfectly (Klatt et al., 2013; Ganiolova & Low, 2018). Major advantages of negative stiffness structure are the recoverable elastic buckling (Ha et al., 2019; Zhakatayev et al., 2020), shock isolation (Shan et al., 2015; San Ha & Lu, 2020; Debeau et al., 2018; Frenzel et al., 2016), and vibration isolation (Frenzel et al., 2016; Chen et al., 2020; Meaud & Che, 2017; Lee et al., 2007; Tan et al., 2019). Negative stiffness honeycomb structure (NSHS) is the most commonly used NSS which absorbs energy through elastic deformation and can be used repeatedly for mechanical energy absorption (Debeau et al., 2018). Plastic buckling is used in regular honeycomb constructions to absorb mechanical energy, whereas elastic buckling is used in negative stiffness honeycombs. As a result, when a load is applied, the negative stiffness honeycomb may absorb a vast amount of energy and deform elastically while it returns to its original structural shape (Correa, Seepersad, & Haberman, 2015) upon removal. Wang et al. (2019) studied the cushioning performance of a cylindrical negative stiffness structure. The impact response characteristics were also evaluated, as were two optimization approaches involving the addition of lattice support to the walls and filling with foam material. The scientists used quasi-static compression and impact tests to evaluate the performance of cushioning and shock absorption. Correa et al. (2015) compared the energy absorption of a normal hexagonal honeycomb against a negative stiffness honeycomb composed of nylon 11. They found that negative stiffness honeycomb and standard hexagonal honeycomb functioned virtually identically, with one noteworthy difference in the negative stiffness honeycomb's capacity to restore to its previous position after the compression force was released. Debeau et al. (2018) manufactured a fully recoverable negative stiffness honeycomb structure and performed quasi-static and impact analysis. They found that the wide zones of negative or quasi-zero stiffness afforded by negative stiffness honeycombs are perfect for shock isolation. The mechanism of NSHS is somewhat similar to a leaf spring and may be an excellent candidate for the design of a leaf spring.

From the above discussion, it is noted that most of the research found in the literature is based on the potential use of composite materials for leaf springs. However, very few works were found in the literature in terms of the structural modification of leaf springs. Therefore, in this work, a novel design of leaf spring is proposed by incorporating NSHS as a potential leaf spring structure since the NSHS is suitable for both energy absorption and shock isolation. A leaf spring is designed using NSHS to analyze its behavior numerically and the structural characteristics are compared with a traditional leaf spring.

2. Computational Modeling

2.1 Materials

DIN 65Si7 is the most commonly used material for automobile leaf springs and it is used for all the models with a modulus of elasticity of 210 GPa and Poisson's ratio of 0.266 (Rajesh & Sreekumar, 2016).

2.2 Methodology

In order to study the feasibility of NSHS as an automobile leaf spring, two models are investigated i.e. traditional and NSHS leaf springs. Fig. 1 (a) shows the schematic diagram of a traditional leaf spring. Two full length leaf are used along with the master leaf and four graduated leaves are used in the traditional leaf spring. The thickness and width of each leaf are 10 mm and 111 mm respectively. The length of the master leaf and two full length leaves are 1000 mm while the length of the four graduated leaves are 571 mm, 428 mm, 285 mm and 142 mm.

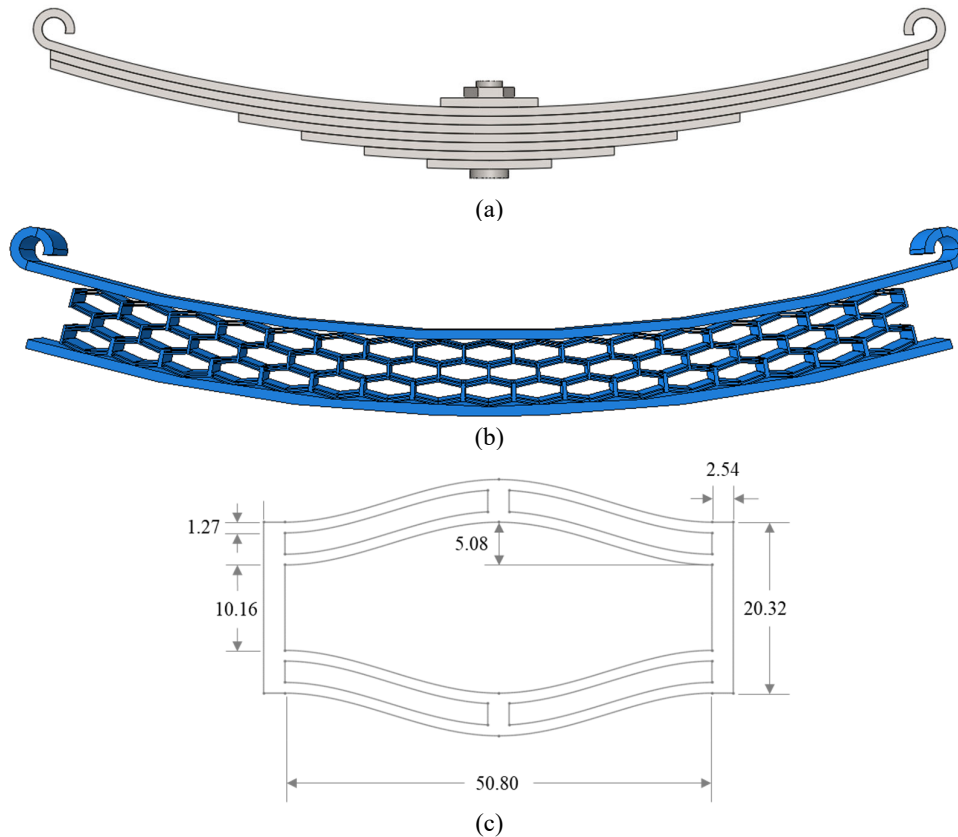

Fig. 1. Schematic diagram of (a) traditional, (b) NSHS leaf spring, and (c) dimensions of the unit cell of NSHS (All dimensions are in mm)

The 3D geometry of the NSHS model is created using Solidworks as shown in Fig. 1 (b). The model consists of 3 parts: a master leaf, a full graduated leaf, and a negative stiffness honeycomb. The master leaf's span length is 1000 mm from the center of one eye to the other, and the thickness of each leaf is 10 mm. The eye diameter is 27 mm for both traditional and NSHS springs. The width of each leaf is 111 mm. The radius of curvature of the top surface of the top leaf for both springs is 1685 mm. The full graduated leaf's span length, width and depth are 1000 mm, 111 mm, and 10 mm respectively. The honeycomb structure is made using the dimensions of the unit cell of the NSHS as shown in Fig. 1 (c). The dimensions of the unit cell in NSHS were taken from (Correa, Klatt, et al., 2015). All the parts are then imported to Abaqus, a commercially available software that was used for analysis in this paper. The same boundary conditions are used for both traditional and NSHS leaf springs.

Fig. 2 shows the load and boundary conditions applied for the analysis where both eyes are restricted in all degrees of freedom except rotation about the X-axis to mimic the practical case (Rajesh & Sreekumar, 2016). Various loads are applied on the bolt at the center of the bottom surface for the conventional leaf spring. Since no bolt is used in the NSHS leaf spring, loads are applied over an equivalent area at the center of the bottom surface.

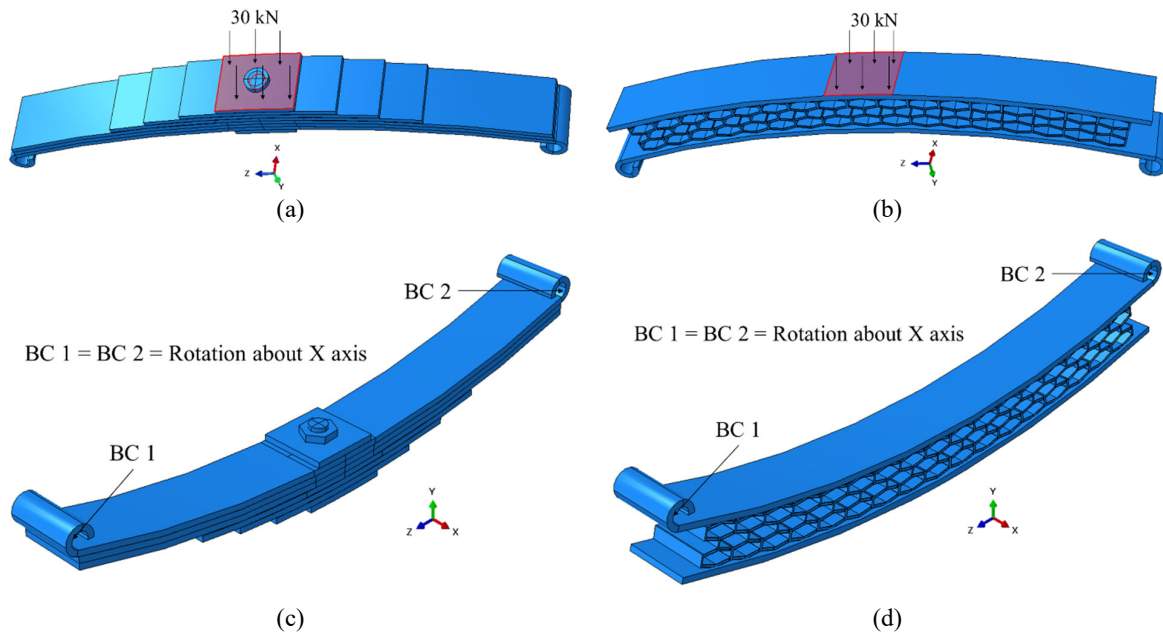

Fig. 2. Loading conditions (a) traditional, (b) NSHS; and boundary conditions (c) traditional, (d) NSHS

Eight-node linear brick elements with reduced integration (C3D8R) are used to mesh all the parts because of their suitability for structural analysis (Hibbitt, Karlsson, & Sorensen, 1997). The typical mesh in the NSHS is shown in Fig. 3. Mesh sensitivity analysis is performed to make the results mesh-independent. It is observed from the mesh sensitivity analysis that if the number of elements increased to more than 225508, the results did not change. So, a total of 225508 elements are used throughout the analysis. For modal analysis, the frequency step is used to determine the modal frequency of the leaf spring. Although, five eigenvalues are used in the analysis the first three modal frequencies are considered as this system can be considered to have three degrees of freedom (Rajesh & Sreekumar, 2016). For structural analysis, the static, general step is used with the load shown in Fig. 2. The static, general step is also used for transient analysis with a variable load. The applied load profile is discussed in section 3.4 in detail.

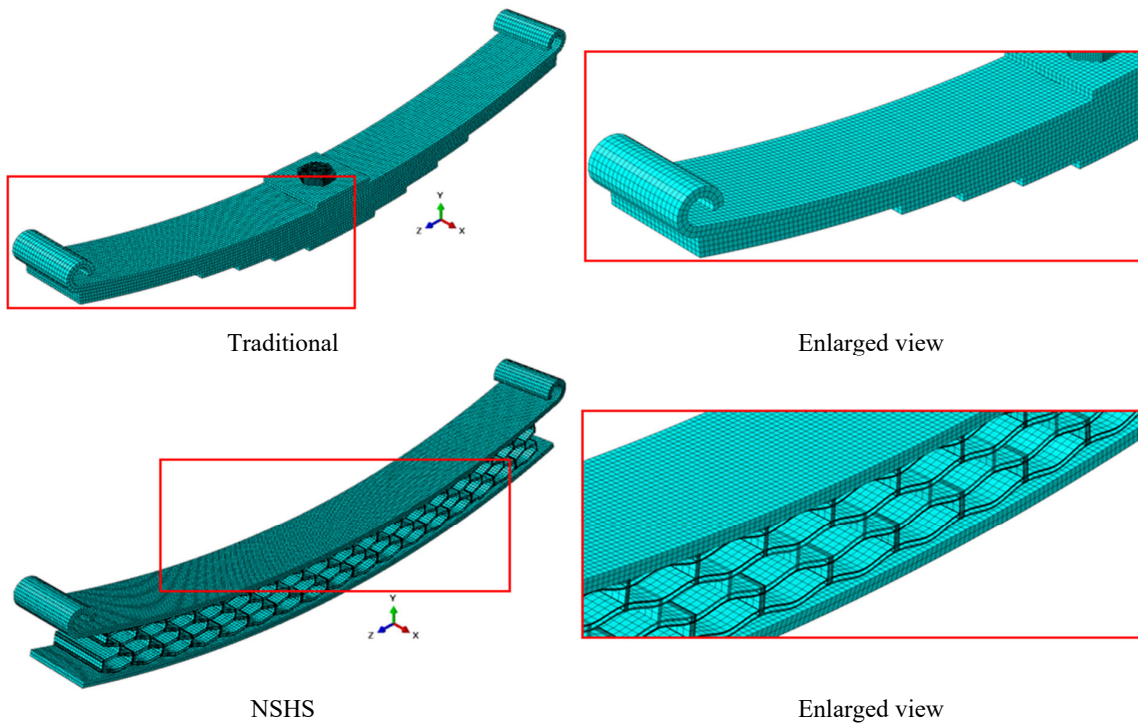

Fig. 3 Typical mesh model of traditional and NSHS leaf springs with an enlarged view

3. Results and Discussions

3.1 Model Validation

Numerical modeling of the conventional leaf spring is carried out using the same material, dimensions, loading, and boundary conditions as Rajesh and Sreekumar (2016). Fig. 4 shows variations of maximum von Mises stress against applied load for the current model and the model analyzed by Rajesh and Sreekumar (2016). It is observed from Fig. 4 that the current model is in good agreement with the results obtained by Rajesh and Sreekumar (2016). The maximum deviation of the current model is found to be 3.26 % which is insignificant. So, the present model can predict stress and other parameters very well.

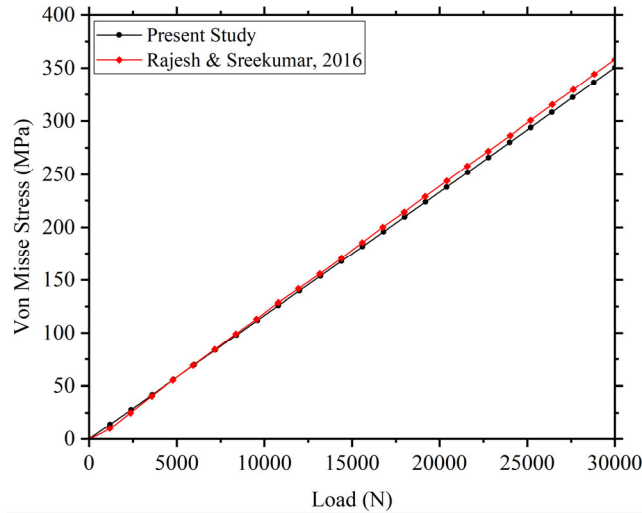
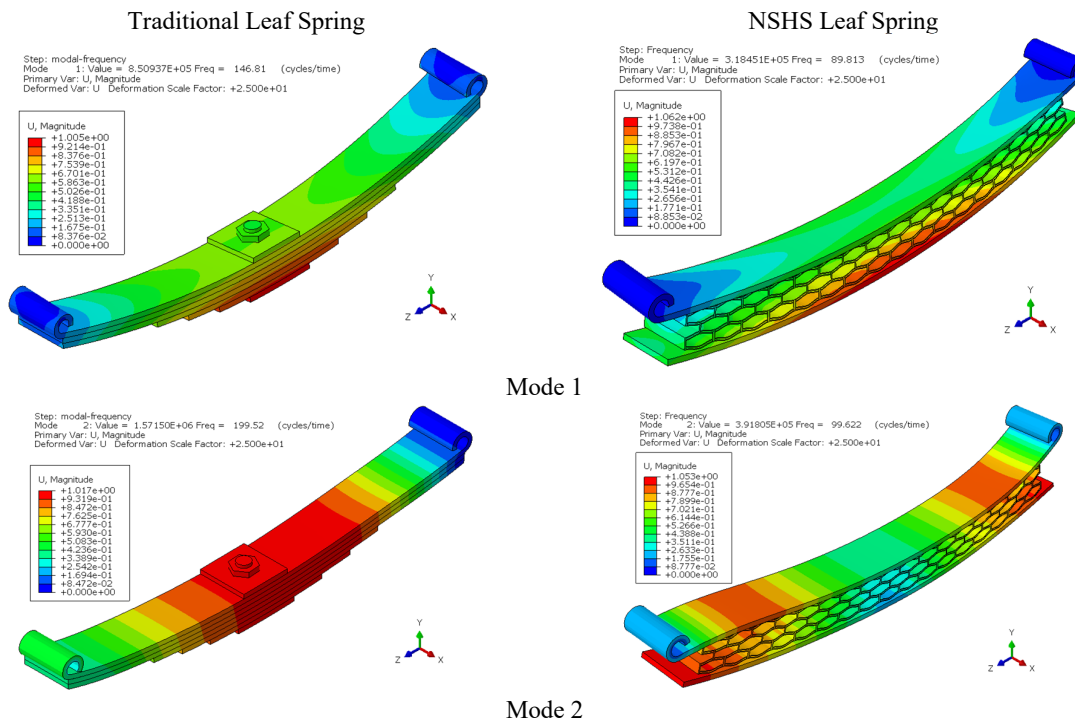
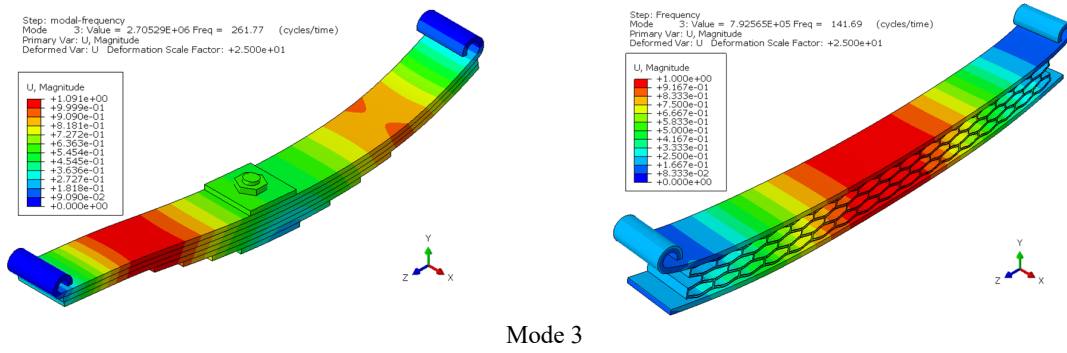

Fig. 4. Comparison of current work with previous studies done by Rajesh et al. (2016) for induced stress against applied load.

3.2 Modal Analysis

Modal analysis is essential to find mode shapes and the natural frequency of leaf springs under free vibrations since the natural frequency and mode shapes are important design parameters (Noronha et al., 2020). So, the modal analysis was performed for both models (traditional and NSHS) to determine their modal frequencies. Fig. 5 shows mode shapes for traditional and NSHS leaf springs corresponding to mode 1, mode 2, and mode 3.





Mode 3
Fig. 5. Mode shapes of traditional and NSHS leaf springs obtained numerically

The maximum amplitude of displacement at the natural frequency for the NSHS leaf spring is greater than the traditional spring for mode 1 and mode 2 however it is less than the traditional spring for mode 3. For mode 1, the maximum displacement occurred at the bottom side of both springs. For mode 2, the maximum displacement occurred around the center of the traditional leaf spring but it took place at the ends of the bottom leaf of the NSHS leaf spring. The maximum displacement for mode 3 occurred at the middle of the center and the eye of the traditional leaf spring but it is found at the center of the NSHS leaf spring.

Table 1 shows the natural frequency of the three modes for both models as well as the total mass of both springs. From this table, it is found that the natural frequency of NSHS leaf spring is lower compared to traditional leaf spring. Although the natural frequency of the NSHS leaf spring is less than traditional leaf spring still it is much higher than the frequency that can be generated by road irregularities. The typical frequency generates from road irregularities is 12 Hz (Kumar & Vijayarangan, 2007; Kim, 1988; Bhanage & Padmanabhan, 2014). So, it should not be a concern if this NSHS leaf spring is used in an automobile as an alternative to traditional leaf springs. Table 1 also shows the total mass of both leaf springs and it is found that the total mass can be reduced by 30.73 % by replacing the traditional leaf spring with an NSHS spring.

Table 1. Modal frequencies of traditional and NSHS leaf spring

Modes	Traditional		NSHS	
	Frequency (Hz)	Mass (kg)	Frequency (Hz)	Mass (kg)
1	146.81		89.81	
2	199.52	41.98	99.62	29.08
3	261.77		141.69	

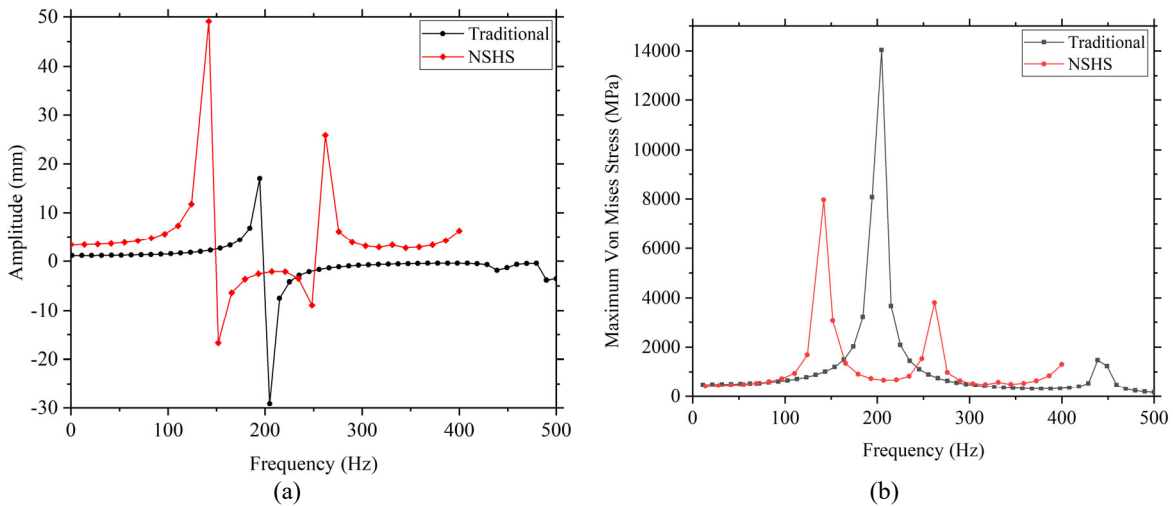

Fig. 6. Frequency response of both springs: (a) amplitude and (b) maximum von Mises stress

The harmonic step was used to obtain amplitude and corresponding frequencies after obtaining modal shapes and natural frequencies. A 30 kN load was applied harmonically and the response was recorded. The amplitude of vibration is shown in Fig. 6 (a) as a function of frequency. For the traditional leaf spring, it is seen that the maximum amplitude is -29.14 mm at a frequency of 204.7 Hz while the maximum amplitude for the NSHS leaf spring is found to be 49.09 mm at a frequency of 137.9 Hz. Fig. 6 (b) shows the maximum von Mises stress developed as a function of frequency. The mean stress for traditional

leaf spring is found to be 1211.22 MPa while for NSHS leaf spring it is 1203.11 MPa. Although their mean stress is almost the same, the peak stress for the NSHS leaf spring (7963 MPa) is significantly lower (43.24 %) than the traditional leaf spring (14030 MPa) at the resonance frequency.

3.3 Structural Analysis

The von Mises stress distribution is shown in Fig. 7. By comparing the stress distribution of traditional and NSHS leaf springs, it is observed that the developed stress in the traditional leaf spring is higher than the NSHS spring. For the traditional leaf spring, the maximum von Mises stress is developed at the eye and the minimum stress is seen on the individual leaves. However, the stress is distributed on the NSHS leaf spring which is better for the safe operation of the leaf spring. Fig. 8 shows the comparison of the maximum von Mises stress of both leaf springs for various loads. The applied load is linearly varied from 0 to 30 kN and the von Mises stress is plotted. This figure shows that the von Mises stress is linearly proportional to the applied load and comparatively lower stress is developed in the case of the NSHS leaf spring. At the maximum applied load i.e. 30 kN, the von Mises stress in the NSHS leaf spring is 12.27 % less than the traditional spring. It should be noted at this point that both springs are made of the same material. This observation signifies that the probability of failure for NSHS leaf spring is lower than that of traditional leaf spring subjected to the same load. It is also noticed that the difference in von Mises stress between traditional and NSHS leaf springs increases with increasing the applied load. It also indicates that the NSHS leaf spring becomes safer with increasing applied load compared to the traditional leaf spring. The lower von Mises stress development in the NSHS leaf spring is attributed to the fact that the load is uniformly distributed to the negative stiffness honeycombs incorporated in the NSHS leaf spring rather than the eye of the spring. It has been shown in the literature that these NSH cells are capable of absorbing a significant amount of elastic energy through buckling (Correa, Seepersad, et al., 2015) which in turn results in a lower stress concentration at the eye of the NSHS leaf spring.

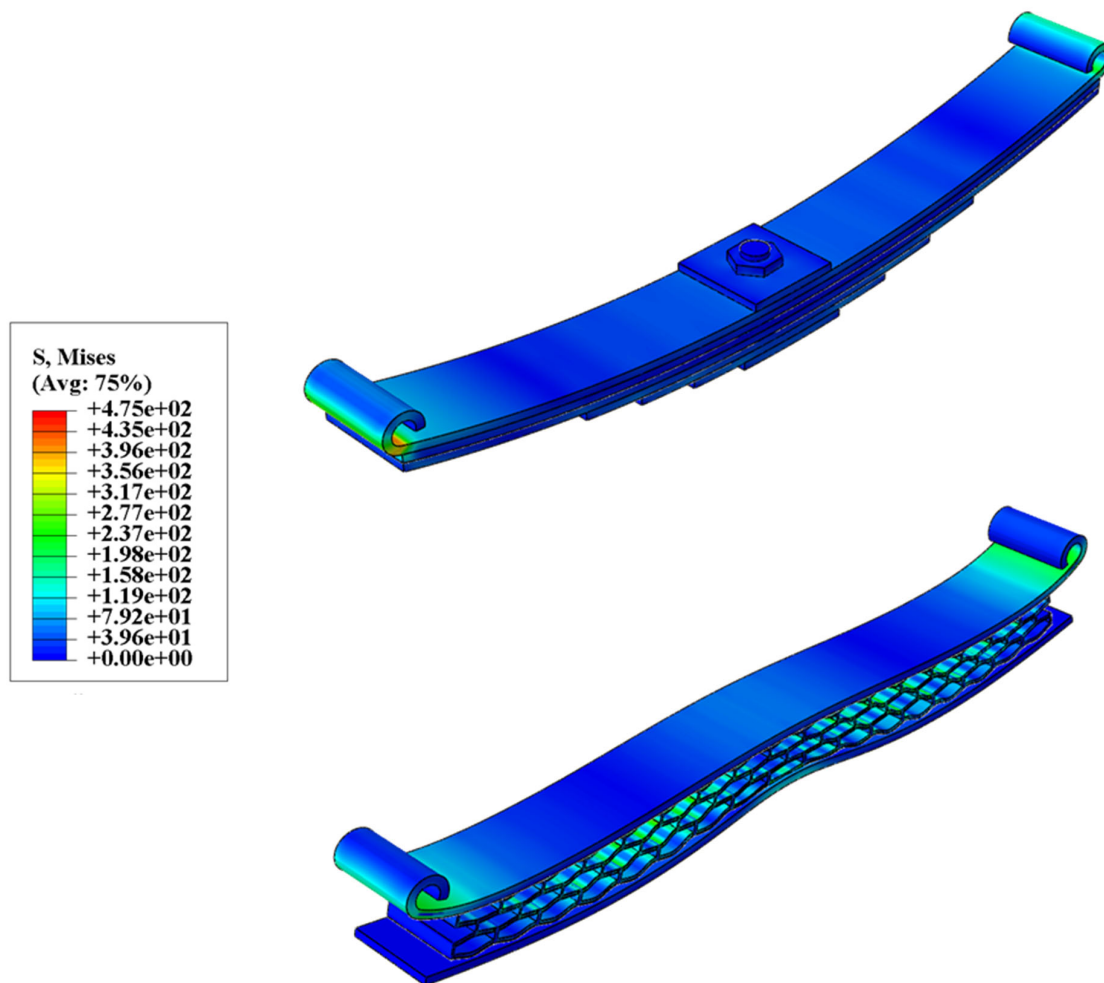

Fig. 7. Stress distribution of traditional and NSHS leaf spring

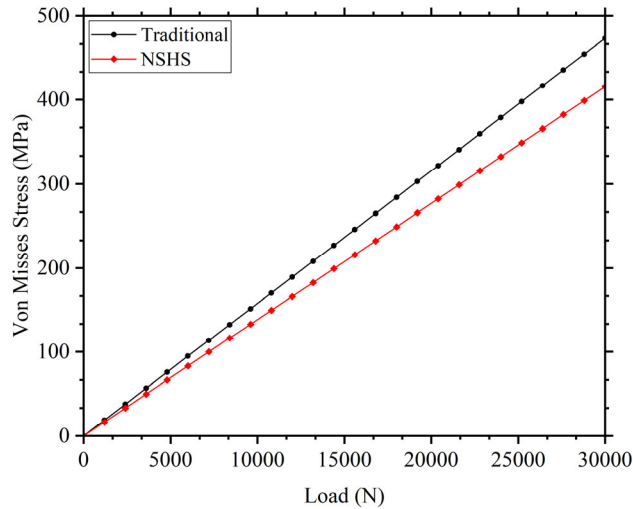

Fig. 8. Von Mises stress vs applied load for both traditional and NSHS leaf springs

The deflection contours for both models are given in Fig. 9 which shows that the deflection in NSHS leaf spring is much higher than in traditional leaf spring. Fig. 10 (a) confirms this statement where the load-deflection response is plotted. The maximum deflection of the traditional leaf spring is found to be 1.14 mm at a 30 kN load while the maximum deflection for the NSHS leaf spring at the same load is 3.39 mm which indicates a 197.37 % increase in deflection under the same load. Since the deflection of the NSHS leaf spring is found higher than the traditional leaf spring, it indicates that the energy absorption (EA) will be higher for the NSHS leaf spring.

The energy absorption and specific energy absorption (SEA) are calculated using the following formulas (Chen et al., 2021)

$$EA = \int_0^{\delta} F(\delta) d\delta \tag{1}$$

$$SEA = \frac{EA}{m} \tag{2}$$

where $F(\delta)$ is the compression force through the displacement δ and m is the mass of the structure.

The elastic energy absorption is calculated using the load-deflection response and shown in Fig. 10 (b). It is found that the EA and SEA of the NSHS spring is 198.5 % and 332.1% higher compared to the traditional leaf spring. It signifies that the ability of shock isolation in the NSHS spring is comparatively better than in the traditional spring. Again this is due to the integration of NSH cells with shock isolation ability (Debeau et al., 2018) in the leaf spring structure.

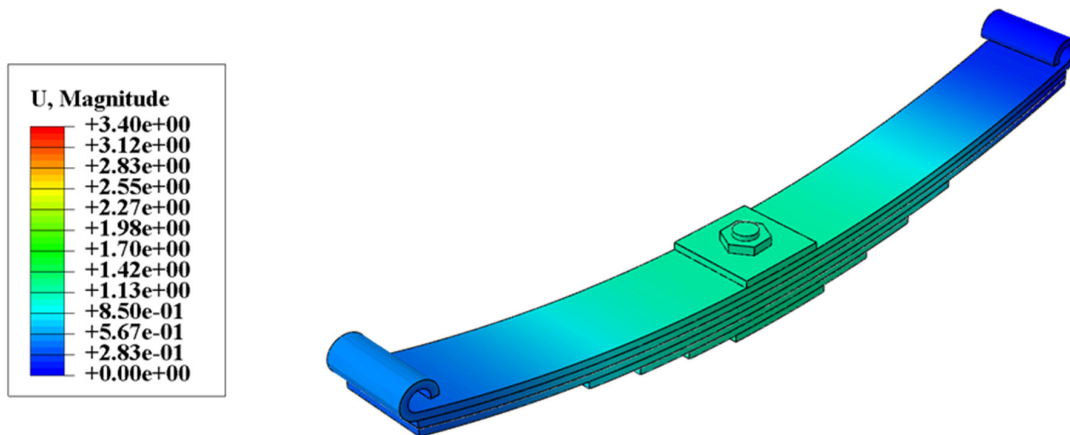

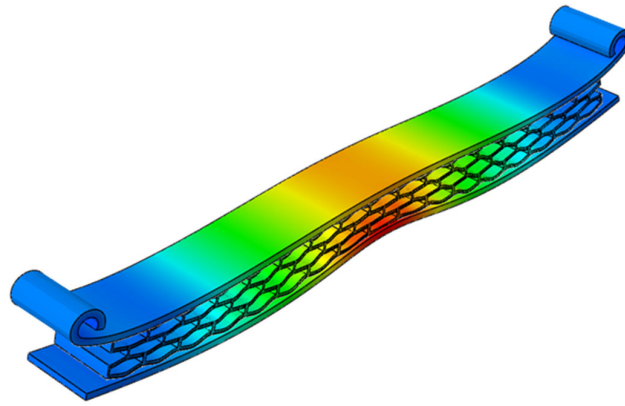

Fig. 9. Deflection of traditional and NSHS leaf spring

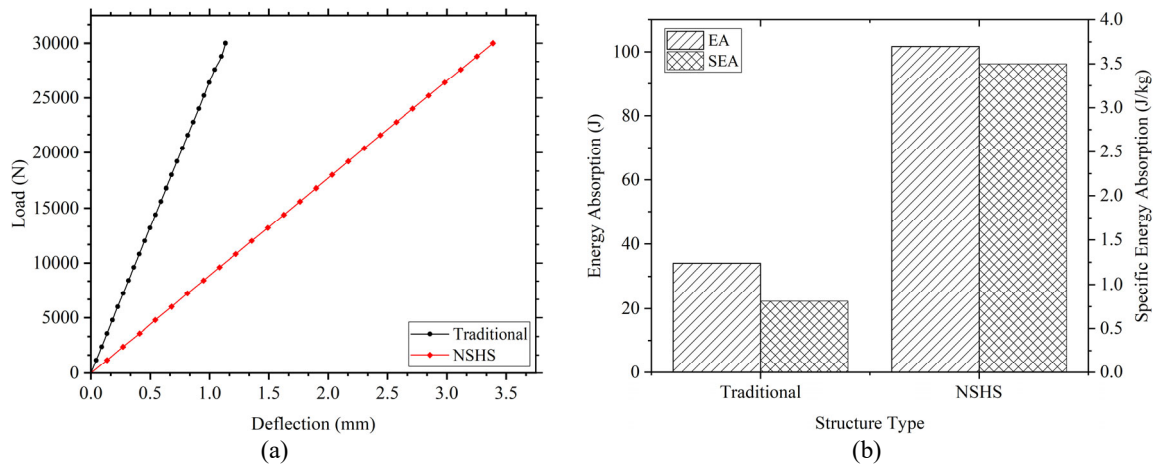

Fig. 10. (a) Load-deflection response, and (b) energy absorption of both traditional and NSHS springs

3.4 Transient Analysis

Transient analysis is also carried out for both models with the same loading and boundary conditions. The maximum value of the applied sine load is 30 kN with a time period of 0.08 s and the total time is considered to be 1 s so that the frequency of loading is 12.5 Hz (slightly greater than the frequency generated from road irregularities i.e. 12 Hz).

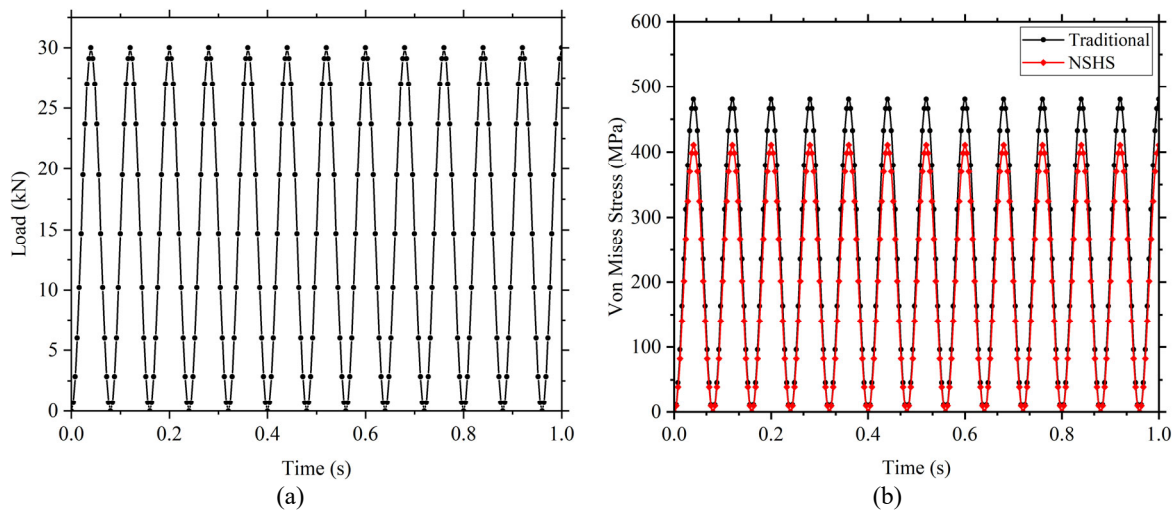

Fig. 11. (a) Typical input load, and (b) comparison of developed stress

The loading cycle with the above-mentioned properties is shown in Fig. 11 (a). The variation of von Mises stress with respect to time for both traditional and NSHS springs is shown in Fig. 11 (b), where it is observed that the stress developed in the NSHS is lower than in the traditional leaf spring. The maximum stress, mean stress, and stress amplitude are tabulated in Table 2. It is observed from this table that the mean stress and stress amplitude in the NSHS leaf spring is reduced by 14.5 % compared to the traditional leaf spring. The transient analysis is very important for a leaf spring as it is subjected to cyclic loading when the vehicle moves. The stress amplitude is crucial in terms of the fatigue life of a leaf spring and a 14.5% reduction in the mean stress and the stress amplitude indicates a longer life of the springs.

Table 2. The von Mises stresses in leaf springs for transient analysis.

Spring Type	Max. Stress, MPa	Mean Stress, MPa	% Reduction	Stress Amplitude, MPa	% Reduction
Traditional	480.53	240.82	-	239.71	-
NSHS	410.77	205.86	14.5	204.92	14.5

3.5 Fatigue Analysis

The fatigue life of a structure is expressed in terms of the number of cycles to failure at various stress levels. The fatigue life of the leaf spring is calculated using Hwang and Han relation (Kumar & Vijayarangan, 2007; Hwang & Han, 1989).

$$N = \{B(1 - r)\}^{1/C} \quad (3)$$

where, N is the number of cycles to failure, B = 10.33, C = 0.14012 and $r = \sigma_{max}/\sigma_{uts}$. Here, σ_{max} is the maximum stress and σ_{uts} is the ultimate tensile strength.

The ultimate tensile strength of the material used is 1272 MPa, and the fatigue life of the leaf spring calculated by using Eq. (3) is tabulated in Table 3 for different applied stress levels-

Table 3. Fatigue life at different stress levels

Maximum Stress (MPa)	Applied Stress Level	Number of Cycles to Failure
127.2	0.1	8143497
254.4	0.2	3513570
381.6	0.3	1354800
410.77 (NSHS)	0.32	1074951
480.53 (Traditional)	0.38	588112
508.8	0.4	450913
636	0.5	122743
763.2	0.6	24967
890.4	0.7	3204
1017.6	0.8	177
1144.8	0.9	-
1272	1.0	-

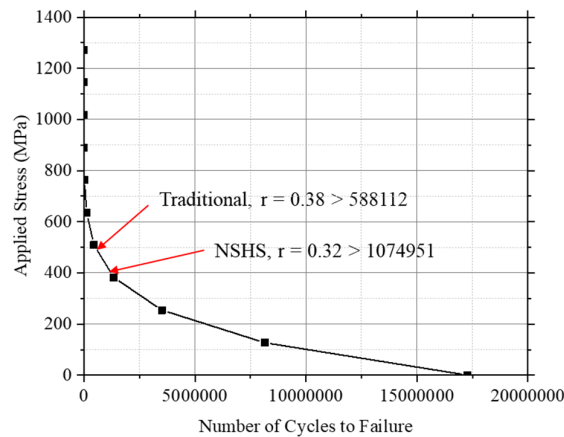

Fig. 12. S-N curve for automobile leaf spring

The maximum stress developed in the traditional leaf spring is 480.53 MPa and it is 410.77 MPa for the NSHS leaf spring as discussed in the previous section. Fig. 12 shows the S-N curve for the automobile leaf spring. For the traditional leaf spring, the applied stress level is 0.38 and for this stress level, the fatigue life is 588112 cycles as marked in Fig. 12. On the other hand, the applied stress level for NSHS is 0.32 and its fatigue life is 1074951 cycles. So, for the NSHS leaf spring, the fatigue life appeared to be 82.78 % greater than the traditional leaf spring. Although the material for both springs is the same, the structural difference makes a significant change in their service life. This analysis indicates that the NSHS leaf spring would have a considerable service life compared to the traditional leaf spring.

4. Conclusion

In this study, a comparative analysis between a traditional leaf spring and a NSHS leaf spring is presented. Modal, harmonic, structural, transient, and fatigue analyses were performed to study the feasibility of NSHS as a potential automobile leaf spring using FEM. Modal analysis showed a reduction in natural frequency of NSHS leaf spring compared to the traditional leaf spring but the reduced frequency is found to be significantly higher than the frequency produced by the road irregularities. The mass of NSHS spring is reduced by 30.73 % compared to the traditional spring. From the harmonic analysis, it is found that the maximum von Mises stress for the NSHS leaf spring is 43.24 % lower than the traditional leaf spring at the resonance frequency. Structural analysis shows that the maximum von Mises stress is reduced by 12.27 % and the energy absorption is increased by 198.5 % for the NSHS leaf spring compared to the traditional spring. A 14.5 % reduction in the mean stress and stress amplitude for NSHS is found from the transient analysis. The fatigue life of the NSHS spring is increased by 82.78 % compared to the traditional leaf spring. So, it can be concluded from this study that the NSHS can be used as a potential leaf spring structure in the automobile however further optimization of the design may be a subject of future research.

Conflict of Interest

The authors declare that they have no conflict of interest.

References

- Baviskar, A., Bhamre, V., & Sarode, S. (2013). Design and Analysis of a Leaf Spring for automobile suspension system: a review. *International Journal of Emerging Technology and Advanced Engineering*, 3(6), 407-410.
- Bhanage, A., & Padmanabhan, K. (2014). Design for fatigue and simulation of glass fibre/epoxy composite automobile leaf spring. *ARP Journal of Engineering and Applied Sciences*, 9(3), 196.
- Chen, S., Tan, X., Hu, J., Zhu, S., Wang, B., Wang, L., . . . Wu, L. (2021). A novel gradient negative stiffness honeycomb for recoverable energy absorption. *Composites Part B: Engineering*, 215, 108745.
- Chen, S., Wang, B., Zhu, S., Tan, X., Hu, J., Lian, X., . . . Wu, L. (2020). A novel composite negative stiffness structure for recoverable trapping energy. *Composites Part A: Applied science and manufacturing*, 129, 105697.
- Correa, D. M., Klatt, T., Cortes, S., Haberman, M., Kovar, D., & Seepersad, C. (2015). Negative stiffness honeycombs for recoverable shock isolation. *Rapid Prototyping Journal*.
- Correa, D. M., Seepersad, C. C., & Haberman, M. R. (2015). Mechanical design of negative stiffness honeycomb materials. *Integrating Materials and Manufacturing Innovation*, 4(1), 165-175.
- D'Silva, S., & Jain, S. (2014). Design of a modified leaf spring with an integrated damping system for added comfort and longer life. *International Journal of Research in Engineering and Technology*, 3(1), 30-34.
- Debeau, D. A., Seepersad, C. C., & Haberman, M. R. (2018). Impact behavior of negative stiffness honeycomb materials. *Journal of Materials Research*, 33(3), 290-299.
- Frenzel, T., Findeisen, C., Kadic, M., Gumbsch, P., & Wegener, M. (2016). Tailored buckling microlattices as reusable light-weight shock absorbers. *Advanced Materials*, 28(28), 5865-5870.
- Ganilova, O. A., & Low, J. J. (2018). Application of smart honeycomb structures for automotive passive safety. *Proceedings of the Institution of Mechanical Engineers, Part D: Journal of Automobile Engineering*, 232(6), 797-811.
- Ha, C. S., Lakes, R. S., & Plesha, M. E. (2019). Cubic negative stiffness lattice structure for energy absorption: Numerical and experimental studies. *International Journal of Solids and Structures*, 178, 127-135.
- Hibbitt, Karlsson, & Sorensen. (1997). *ABAQUS: theory manual* (Vol. 2): Hibbitt, Karlsson & Sorensen.
- Hwang, W., & Han, K. S. (1989). *Fatigue of composite materials--damage model and life prediction*: ASTM International.
- Ismaeel, L. M. A. (2015). Optimization and static stress analysis of hybrid fiber reinforced composite leaf spring. *Advances in Materials Science and Engineering*, 2015.
- Kim, W. J. Y. a. H. C. (1988). Double Tapered FRP Beam for Automotive Suspension Leaf Spring. *Composite Structures*, 9(1988), 279-300.
- Klatt, T., Haberman, M., & Conner Seepersad, C. (2013). *Selective laser sintering of negative stiffness mesostructures for recoverable, nearly-ideal shock isolation*. Paper presented at the 2013 International Solid Freeform Fabrication Symposium.
- Krishan, K., & Aggarwal, M. (2012). A finite element approach for analysis of a multi leaf spring using CAE tools. *Res. J. Recent Sci*, 2277, 2502.
- Kumar, M. S., & Vijayarangan, S. (2007). Static analysis and fatigue life prediction of steel and composite leaf spring for light passenger vehicles.

- Lee, C.-M., Goverdovskiy, V., & Temnikov, A. (2007). Design of springs with “negative” stiffness to improve vehicle driver vibration isolation. *Journal of sound and vibration*, 302(4-5), 865-874.
- May Mya Darli Cho, H. H. W. a. A. K. L. (2017). *Design and Analysis of Leaf Spring for Solar Vehicle* Paper presented at the IIER International Conference, Bangkok, Thailand.
- Meaud, J., & Che, K. (2017). Tuning elastic wave propagation in multistable architected materials. *International Journal of Solids and Structures*, 122, 69-80.
- Mehul, S., Shah, D. B., & Bhojawala, V. (2012). Analysis of composite leaf spring using FEA for light vehicle mini truck. *Journal of Information, Knowledge and Research in Mechanical Engineering*, 2(2), 424-428.
- Noronha, B., Yesudasan, S., & Chacko, S. (2020). Static and dynamic analysis of automotive leaf spring: a comparative study of various materials using ANSYS. *Journal of Failure Analysis and Prevention*, 20(3), 804-818.
- Rajesh, N. H., & Sreekumar, M. (2016). Design and simulation of a novel hybrid leaf spring with embedded cylindrical structures. *International Journal of Heavy Vehicle Systems*, 23(2), 131-154.
- Rao, P. S., & Venkatesh, R. (2015). Modal and harmonic analysis of leaf spring using composite materials. *International Journal of Novel Research in Electrical and Mechanical Engineering*, 2(3), 67-75.
- San Ha, N., & Lu, G. (2020). A review of recent research on bio-inspired structures and materials for energy absorption applications. *Composites Part B: Engineering*, 181, 107496.
- Shamim, S., & Anwer, J. (2014). Design and optimization of automotive multi-leaf spring by finite element method. *IJRAME*, 2, 46-54.
- Shan, S., Kang, S. H., Raney, J. R., Wang, P., Fang, L., Candido, F., . . . Bertoldi, K. (2015). Multistable architected materials for trapping elastic strain energy. *Advanced Materials*, 27(29), 4296-4301.
- Shankar, G. S. S., & Vijayarangan, S. (2006). Mono composite leaf spring for light weight vehicle—design, end joint analysis and testing. *Materials science*, 12(3), 220-225.
- Soner, M., Guven, N., Kanbolat, A., Erdogus, T., & Karaagac, M. (2011). Parabolic leaf spring design optimization considering FEA & rig test correlation: SAE Technical Paper.
- Tan, X., Wang, B., Chen, S., Zhu, S., & Sun, Y. (2019). A novel cylindrical negative stiffness structure for shock isolation. *Composite Structures*, 214, 397-405.
- Wang, B., Tan, X., Zhu, S., Chen, S., Yao, K., Xu, P., . . . Sun, Y. (2019). Cushion performance of cylindrical negative stiffness structures: Analysis and optimization. *Composite Structures*, 227, 111276.
- Zhakatayev, A., Kappassov, Z., & Varol, H. A. (2020). Analytical modeling and design of negative stiffness honeycombs. *Smart Materials and Structures*, 29(4), 045024.
- Zou, X., Zhang, B., & Yin, G. (2022). Analysis of stiffness and damping performance of the composite leaf spring. *Scientific Reports*, 12(1), 1-10.



© 2023 by the authors; licensee Growing Science, Canada. This is an open access article distributed under the terms and conditions of the Creative Commons Attribution (CC-BY) license (<http://creativecommons.org/licenses/by/4.0/>).